



H-ENGM0408, April 2008

(Replaces H-ENGM0806, August 2006)

Engineering Manual

Commercial Refrigeration
Cooling and Freezing
Load Calculations and Reference Guide

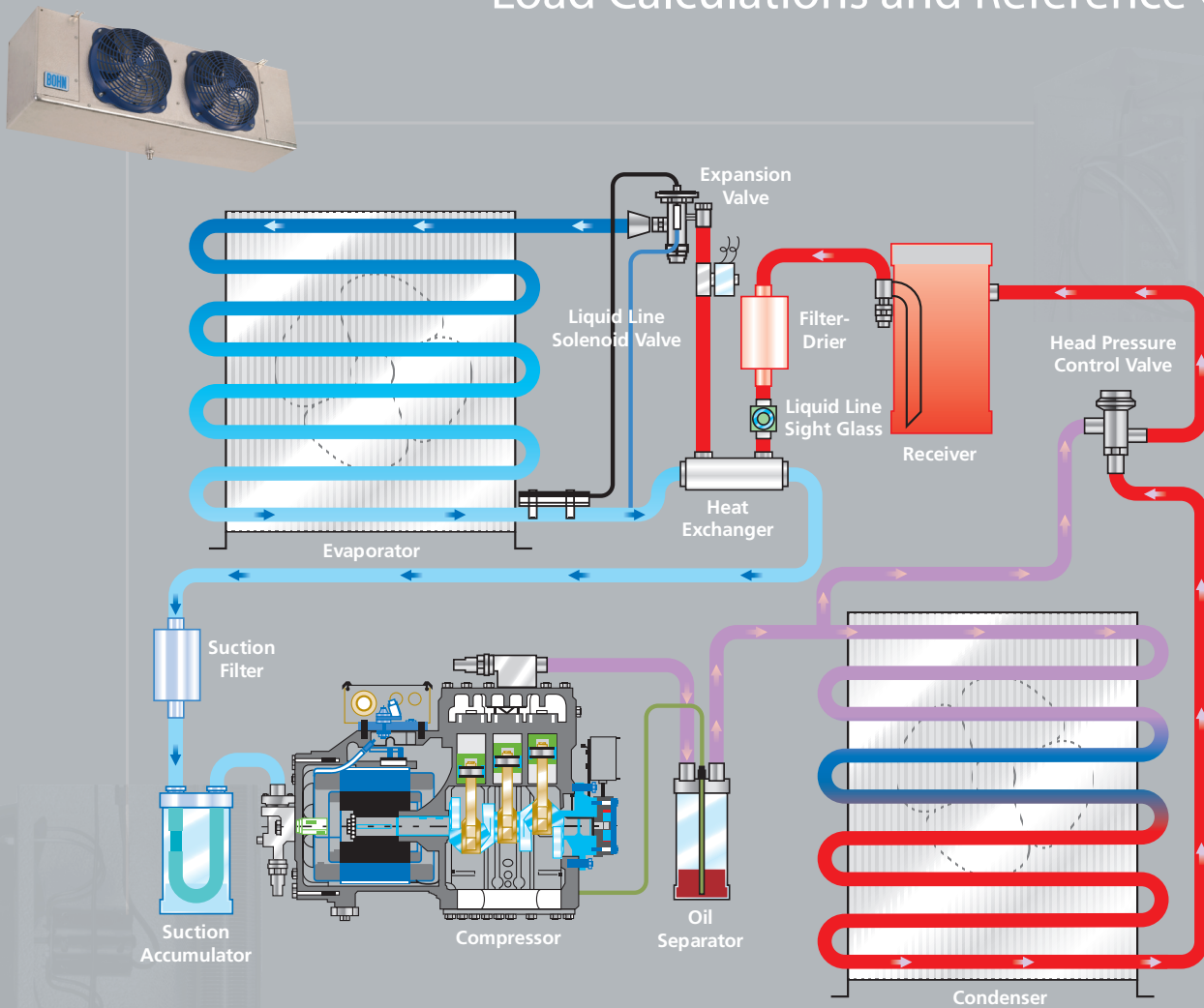

Forward

This edition of Heatcraft Refrigeration Products LLC's, Engineering Manual covering Commercial Refrigeration Cooling and Freezing Load Calculations has been prepared in the form of a condensed text and reference book.

The theory and principle of modern refrigeration has been omitted due to the many excellent publications currently available

on these subjects. The purpose of this reference book is to furnish the engineering, selling and servicing organizations with accurate and useful data to simplify load calculations.

No attempt has been made to specify a particular make of equipment. We sincerely hope that our efforts will be a tangible contribution to our rapidly growing industry.

Table of Contents

Job Survey	4	Derating Factors	22
Refrigeration Load Calculations	4-6	General Guidelines	23
Sample Calculations:		Unit Cooler Coil Placement	24
Above 32°F. (0°C.)	7-9	Sizing of Refrigerant Lines	25-32
Sample Calculations:		Psychrometric Chart	37-39
Rooms Below 32°F. (0°C.)	10-12	Glossary of Refrigeration Terms	40
Refrigeration Equipment Selection	21	Quick Selection Guide	41
Type of Operation and Air Flow	22	Rapid Load Calculator for Large Coolers & Freezers	43

Refrigeration Equipment References on the World Wide Web



History of Leadership, Service and Innovation
Bohn has been the Supermarket Industry's leading brand of refrigeration products since 1946. With an emphasis on innovation and the environment, Bohn is the clear choice for meeting the demanding needs of this industry both in the United States and globally.

www.thecoldstandard.com



History of High Performance, Innovation and Product Selection
Larkin has been the most trusted brand of refrigeration products for clean environments since 1928. With its innovative products, it is uniquely qualified to meet the needs of foodservice applications as well as mission critical applications such as data centers.

www.larkinproducts.com



History of Dependability, Technical Support and Product Choice
Climate Control is the brand that revolutionized

convenience store refrigeration in the 1970's. Its reputation of dependability and products designed to reduce installation and operation costs still make it the number one choice of convenience store owners everywhere.

www.coldyoucancounton.com



Serving the Cold Storage Industry with Engineered Solutions
Chandler has been a

leading commercial refrigeration brand since 1933. Its emphasis on partnership allows customers to give input during the system design process, resulting in customized solutions that are precisely engineered to order.

www.chandlerref.com



www.interlinkparts.com

Right source. Right parts. Right now.
We are your link to a complete line of dependable and certified commercial refrigeration parts, accessories and innovative electronic controls. Dependable. Versatile. Courteous. Finally, one simple source for all of your parts needs from a name you can trust.

Tables

Table No.	page No.	Table No.	page No.
1. Wall heat loads.....	13	18. Rapid load selection for back bars.....	19
2. Insulated block K factors.....	13	19. Refrigeration requirements for hardening ice cream.....	19
3. Allowance for sun effect.....	13	20. Glass door load.....	19
4. Average air changes per 24 hours for storage rooms above 32°F. (0°C.) due to door openings and infiltration.....	14	21. Summer outside air and ground temperature design conditions.....	20
5. Average air changes per 24 hours for storage rooms below 32°F. (0°C.) due to door openings and infiltration.....	14	22. Suction and liquid line sizes for R-134A.....	25, 26
6. Heat removed in cooling air to storage room conditions (BTU per Cu. Ft.).....	14	23. Suction and liquid line sizes for R-22.....	27, 28
7. Storage requirements and properties of perishable products.....	15-16	24. Suction & liquid line sizes for R-404A, R-507/AZ50.....	29, 30
8. Heat of respiration.....	17	25. Pressure drop of liquid refrigerants in vertical risers.....	31
9. Heat loads of keg and bottled beer.....	18	26. Equivalent feet of pipe for valves and fittings.....	31
10. Carcass weights.....	18	27. Remote condenser line sizes for R-134A, R-22, R-507/AZ50 and R-404A.....	32
11. Heat equivalent of electric motors.....	18	28. L-type tubing– weight of refrigerants in copper lines of operating systems.....	33
12. Heat equivalent of occupancy.....	18	29. Fahrenheit-Celsius temperature conversion chart.....	34
13. General standards for insulation thickness in storage rooms.....	18	30. Conversion factors.....	35
14. Heat gain due to operation of battery lift trucks.....	18	31. Electrical formulas.....	35
15. Specific heats of various liquids and solids.....	18	32. English conversion factors and data.....	36
16. Banana room refrigeration requirement.....	19	33. English to metric conversion factors.....	36
17. Meat cutting or preparation room.....	19		

Job Survey

The person involved in a heat transfer calculation needs information in order to predict accurately the heat load on a refrigerated structure. The more complete the information, the better the calculation. Good calculations are the first step in assuring adequate refrigeration equipment is selected for the project.

The initial job survey should be as complete as possible and include the following:

Design Ambient Temperature

This is the ambient surrounding the box necessary for the load calculations. Another ambient to be considered on air cooled projects is the one surrounding the condensing unit which will affect equipment selection.

Storage Temperature and Humidity Requirements

Refrigeration equipment by its nature is a dehumidification process. We try to minimize or maximize the drying effect of the equipment by selecting the appropriate Temperature Difference (T.D.) between the saturated suction temperature of the evaporator and the room air. The T.D. selected approximates the desired relative humidity (see page 21).

Dimensions, Insulation, Type of Construction, Exposure

This criterion lends itself to well established, straight forward calculations, but the information while elementary, is often omitted from the initial job survey. Transmission load for 4" Styrofoam is double the transmission load for 4" formed in place urethane.

Infiltration or Air Changed Load

Heat, both sensible and latent, enters an enclosure through door openings whenever the air surrounding the enclosure is warmer than the box temperature. Knowing the location, size and number of the door openings and the temperature to which they are exposed will greatly aid in determining the heat load of the infiltration air.

Product

1. Type - storage requirements
2. Weight
3. Entering temperature
4. Pull down time

Miscellaneous Loads

1. Lights
2. Motors including fan motors, fork lifts, conveyers
3. People
4. Glass doors

Operations

1. Holding cooler or freezer
2. Blast cooling or freezing
3. Preparation, processing or cutting rooms
4. Distribution warehouses
5. Reach-in or walk-in boxes

Unusual Conditions

Electrical Service and Type of Equipment Desired

While not directly affecting refrigeration load calculations, this is essential in the job survey to select the proper equipment.

Refrigeration Load Calculations

With the initial survey complete, the heat load calculation is separated into the following main sources of heat for a given 24 hour period:

1. Transmission load
2. Air change load
3. Miscellaneous load
4. Product load

Accuracy

Accuracy in calculation is the first step in having a satisfied customer. There are short cuts, based on averages, that may be taken and which must be used when the product load is indefinite or unknown (see Quick Selection Guide on page 41 and the Rapid Load Calculator on page 43). But when all the data necessary to calculate the four main sources of heat gain are available, the complete calculation should be made.

Quick Selection Chart for Small and Medium Coolers and Freezers

The Quick Selection Guide on page 41 may be used for a quick comparison of heat load figured on Bulletins Above32-05 or Below32-05 or to obtain approximate heat loads for small and medium sized boxes. The loads are shown for a 95°F. outside temperature.

Rapid Load Calculator for Large Coolers and Freezers

The Rapid Load Calculator on page 43 may be used for quick approximations of the heat load in large boxes and for a reasonable comparison of heat loads figured on Bulletins Above32-05 or Below32-05. The Calculator graph on page 43 is based on the following average daily product loadings for coolers and freezers:

Volume- Cu. Ft.	Average Daily Product Loads (lbs.) for Coolers	Average Daily Product Loads (lbs.) for Freezers
500 - 3,000	6,200 - 8,000	1,600 - 2,000
3,000 - 4,600	8,000 - 11,000	2,000 - 2,500
4,600 - 8,100	11,000 - 17,000	2,500 - 4,000
8,100 - 12,800	17,000 - 26,000	4,000 - 6,200
12,800 - 16,000	26,000 - 33,000	6,200 - 7,500
16,000 - 20,000	33,000 - 40,000	7,500 - 9,500
20,000 - 28,000	40,000 - 56,000	9,500 - 13,000
28,000 - 40,000	56,000 - 66,000	13,000 - 17,000
40,000 - 60,000	66,000 - 110,000	17,000 - 25,000
60,000 - 80,000	110,000 - 150,000	25,000 - 34,000
80,000 - up	150,000 - up	34,000 - up

1. Transmission Load

Methods of determining the amount of heat flow through walls, floor and ceiling are well established. This heat gain is directly proportional to the Temperature Difference (T.D.) between the two sides of the wall. The type and thickness of insulation used in the wall construction, the outside area of the wall and the T.D. between the two sides of the wall are the three factors that establish the wall load. Tables are provided to simplify the calculations (see Table 1, page 13). Some coolers for above freezing temperatures have been constructed with only a floor slab (no floor insulation). The factors shown in the wall heat gain (Table 1) are based on a concrete floor slab and the T.D. between the local ground temperature and the storage room temperature.

For freezers it becomes necessary to provide heat in the base slab to avoid freezing of the ground water and heaving of the floor. Minimum slab temperature should be at least 40°F. Normally, 55°F. should be used for freezer applications.

2. Air Change Load

(a) Average Air Change- when the door to a refrigerated room is opened, warm outside air will enter the room. This air must be cooled to the refrigerated room temperature, resulting in an appreciable source of heat gain. This load is sometimes called the infiltration load. The probable number of air changes per day and the heat that must be removed from each cubic foot of the infiltrated air, are given in tables based on experience (see Table 4, 5 & 6, page 14). For heavy usage, the infiltration may be doubled or more.

(b) Infiltration Through a Fixed Opening- As an alternate to the average air change method using the Psychrometric Chart (page 37), the following formulas may be used to calculate the infiltration resulting from natural ventilation (no wind) through external door openings.

$$\frac{[(4.88) (\text{door height}) (\text{area}/2) (\text{minutes open}) (\text{temp. diff. } ^\circ\text{F.}) (\text{enthalpy incoming air} - \text{enthalpy warehouse air})] [(1-X)]}{\text{Specific Volume of Incoming Air}}$$

Where X = % of heat transmission blocked by thermal barrier.

The air change load can be substantial and every means should be taken to reduce the amount of infiltration entering the box. Some effective means of minimizing this load are:

- Automatic closing refrigerator doors
- Vestibules or refrigerated anterooms
- Plastic strip curtains
- Air Curtains
- Inflated bumpers on outside loading doors.

3. Miscellaneous Loads

Although most of the heat load in a refrigerated room or freezer is caused by wall heat leakage, air changes and product cooling or freezing, there are three other heat sources that should not be overlooked prior to the selection of the refrigeration equipment. Since the equipment has to maintain temperature under design conditions, these loads are generally averaged to a 24 hour period to provide for capacity during these times.

(a) Lights- typically storage requirements are 1 to 1-1/2 watt per square foot. Cutting or processing rooms can be double the wattage. Each watt is multiplied by 3.42 BTU/watt to obtain a BTUH figure. This is then multiplied by 24 to obtain a daily figure.

(b) Motors- smaller motors are usually less efficient and tend to generate more heat per horsepower as compared to larger motors. For this reason Table 11, on page 18, is broken down in to H.P. groups. Also, motors inside the refrigerated area will reject all of their heat losses as shown in Table 11. However, motors that are located outside but do the work inside, like a conveyor, will reject less heat into the refrigerated space. If powered material handling equipment is used, such as forklift trucks, this must be included under Motor Heat Loads. Generally only battery operated lift trucks are used in refrigerated rooms, which represent a heat gain of 8,000 to 15,000 BTU/hr. or more over the period of operation. If motor or loading conditions are not known, then calculate one motor horsepower for each 16,000 cubic foot box in a storage

cooler and one HP for each 12,500 C.F. in a storage freezer which allows for fan motors and some forklift operations. These figures can be higher in a heavily used area, i.e. loading dock or distribution warehouse.

(c) Occupancy- People working in the refrigerated storage area dissipate heat at a rate depending on the room temperature (Table 12, page 18). Multiple occupancies for short periods should be averaged over a 24 hour period. If occupancy load is not known, allow one person per 24 hour for each 25,000 cubic foot space.

4. Product Load

Whenever a product having a higher temperature is placed in a refrigerator or freezer room, the product will lose its heat until it reaches the storage temperature. This heat load consists of three separate components: (see Table 7, page 15-16).

(a) Specific Heat- The amount of heat that must be removed from one pound of product to reduce the temperature of this pound by 1°F., is called its specific heat. It has two values: one applies when the product is above freezing; the second is applicable after the product has reached its freezing point.

(b) Latent Heat- The amount of heat that must be removed from one pound of product to freeze this pound is called the latent heat of fusion.

Most products have a freezing point in the range of 26°F. to 31°F. If the exact temperature is unknown, it may be assumed to be 28°F.

There is a definite relationship between the latent heat of fusion and the water content of the product and its specific and latent heats.

Estimating specific and latent heats:

Sp. Ht. above freezing = 0.20 + (0.008 X % water)

Sp. Ht. below freezing = 0.20 + (0.008 X % water)

Latent Heat = 143.3 X % water

(c) Respiration- Fresh fruits and vegetables are alive. Even in refrigerated storage they generate heat which is called the heat of respiration. They continually undergo a change in which energy is released in the form of heat, which varies with the type and temperature of the product. Tabulated values are usually in BTU/lb./24 hours (Table 8, page 17), and are applied to the total weight of product being stored and not just the daily turnover.

(d) Pull down Time- When a product load is to be calculated at other than a 24 hour pull down, a correction factor must be multiplied to the product load.

$$\frac{24 \text{ hours}}{\text{Pull down Time}}$$

Note: While product pull down can be calculated, no guarantee should be made regarding final product temperature due to many uncontrollable factors (i.e., type of packaging, position in the box, method of stacking, etc.)

5. Safety Factor

When all four of the main sources of heat are calculated, a safety factor of 10% is normally added to the total refrigeration load to allow for minor omissions and inaccuracies (additional safety or reserve may be available from the compressor running time and average loading).

6. Hourly Heat Load

The hourly heat load serves as the guide in selecting equipment. It is found by dividing the final BTU/24 hour load by the desired condensing unit run time.

35°F. rooms with no timer 16 hr.

35°F. rooms with timer 18 hr.

Blast coolers/Freezers with positive defrost 18 hr.

Storage Freezers 18-20 hr.

25°F. - 34°F. coolers with hot gas or electric defrost 20-22 hr.

50°F. rooms and higher with coil temperature above 32°F. 20-22 hr.

7. Load Calculation Forms

To simplify the calculation and tabulation of refrigeration loads, there are two forms available:

Bulletin Above32-05 is used for all rooms above 32°F. (0°C.)

Bulletin Below32-05 is used for all rooms below 32°F. (0°C.)

All data and tables necessary to fill in the Load Calculation Forms can be found in this manual.

A Word of Caution: The refrigeration load calculation methods presented in this manual are intended for use in selecting refrigeration equipment for rooms used for holding and sometimes pulling product temperature down. For process or unusual applications such as blast freezing or food processing situations, please contact our Application Engineering Department.



Refrigeration Load Estimate Form (for rooms above 32°F) Bulletin Above32-05

Estimate for:

Estimate by:

Date:

Example: 35°F Convenience Store Cooler With Glass Doors

Basis for Estimate

Room Dimensions: Width 8 ft. Length 8 ft. Height _____ ft.

Volume: (L) 28 x (W) 8 x (H) 1792 = _____ cu. ft.

Ambient Temp 85 °F. (Corrected for sun load) — Room Temp 50 °F. = _____ °F. T.D.

Note: Tables can be found in Engineering Manual, H-ENG-2

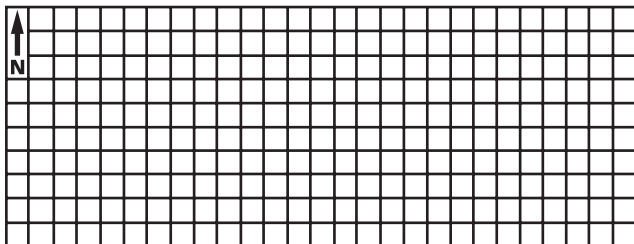

	Insulation	
	Inches	Type
Ceiling	4	Styrene
Walls	4	Styrene
Floor	6	Concrete

Product Load

(a) 2000 lbs./day Beer to be reduced from entering temp. of 85 °F. to 35 °F. Temp. Drop _____ °F.

(b) 200 lbs./day Milk to be reduced from entering temp. of 40 °F. to 35 °F. Temp. Drop _____ °F.

Miscellaneous

Motors (including all blower motors) 0.2 HP Ground Temp. _____ (Table 21)

Lights (assume 1 watt/sq.ft.) 224 Watts

No. of people 0

1. Transmission Loads

Ceiling: (L) <u>28</u> x (W) <u>8</u> x (H) _____	at Load _____ (Table 1)	16128	=	_____
North Wall: (L) <u>28</u> x (H) _____	at Load _____ (Table 1)	16128	=	_____
South Wall: (L) <u>28</u> x (H) _____	at Load _____ (Table 1)	16128	=	_____
East Wall: (W) <u>3</u> x (H) _____	at Load _____ (Table 1)	4608	=	_____
West Wall: (W) <u>3</u> x (H) _____	at Load _____ (Table 1)	4608	=	_____
Floor: (L) <u>28</u> x (W) <u>8</u>	at Load _____ (Table 1)	28000	=	_____

2. Air Change Load

Volume: 1792 cu. ft. x _____ Factor (Table 4) x _____ Factor (Table 6)

43331 = _____

3. Additional Loads

Electrical Motors <u>0.2</u> HP x 75000 BTU/HP/24 hr.	15000	=	_____
Electrical Lights <u>224</u> Watts x 82	18368	=	_____
People Load: <u>0</u> People x _____ BTU/24 hrs. (Table 12)	=	=	_____
Glass Door Load: <u>10</u> Doors x 19200 BTU/Door/24 hr.	192000	=	_____

4. Product Load: Sensible (Product Load Figured @ 24 hr. Pulldown*)

(a) 2000 lbs./day x 0.92 Spec. Heat (Table 5) x _____ °F. Temp Drop

92000 = _____

(b) 200 lbs./day x 0.93 Spec. Heat (Table 5) x _____ °F. Temp Drop

930 = _____

*For product pulldown time other than 24 hrs. figure 24 hr. load x (24/Pulldown Time)

5. Product Load: Respiration*

(a) _____ lbs. stored x _____ BTU/lbs./24 hrs. (Table 8) = _____

(b) _____ lbs. stored x _____ BTU/lbs./24 hrs. (Table 8) = _____

*For consideration of previously loaded product, a multiplier of (5) is normally applied to the daily product load (Line #4)

Total Refrigeration Load (1+2+3+4+5) BTU/24 hrs. 447229

Add 10% Safety Factor 44723

Total with Safety/Factor BTU/24 hrs. 491952

Divide by No. of Operating Hrs. (16) to obtain BTUH Cooling Requirement 30747

Equipment Selection					
Condensing Unit		Unit Cooler		System Capacity	
Qty.	Model No.	Qty.	Model No.	BTU/hr.	



Refrigeration Load Estimate Form (for rooms above 32°F) Bulletin Above32-05

Estimate for:

Estimate by:

Date:

Example: 35°F Beef Cooler

Basis for Estimate

Room Dimensions: Width 14 ft. Length 8 ft. Height _____ ft.
 Volume: (L) 16 x (W) 8 x (H) 1792 = _____ cu. ft.
 Ambient Temp 95 °F. (Corrected for sun load) — Room Temp 60 °F. = _____ °F. T.D.

Note: Tables can be found in Engineering Manual, H-ENG-2

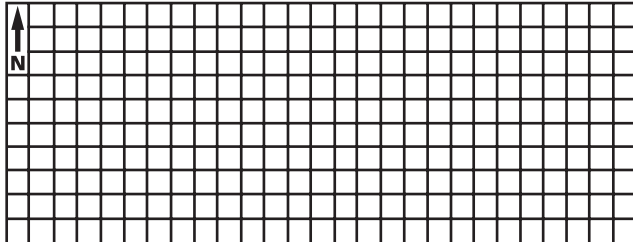

	Insulation	
	Inches	Type
Ceiling	4	Styrene
Walls	4	Styrene
Floor	6	Concrete

Product Load

(a) 1000 lbs./day of Beef to be reduced from entering temp. of 50 °F. to 35 °F. Temp. Drop 15 °F.
 (b) _____ lbs./day of _____ to be reduced from entering temp. of _____ °F. to _____ °F. Temp. Drop _____ °F.

Miscellaneous

Motors (including all blower motors) 0.1 HP Ground Temp. _____ (Table 21)
 Lights (assume 1 watt/sq.ft.) 224 Watts
 No. of people 0

1. Transmission Loads

Ceiling: (U) <u>6</u> (W) <u>14</u> (H) <u>8</u>	Heat Load (Table 1)	<u>19488</u>	=	_____
North Wall: (U) <u>6</u> (W) <u>8</u> (H) <u>8</u>	Heat Load (Table 1)	<u>11136</u>	=	_____
South Wall: (U) <u>6</u> (W) <u>8</u> (H) <u>8</u>	Heat Load (Table 1)	<u>11136</u>	=	_____
East Wall: (W) <u>8</u> (H) <u>8</u>	Heat Load (Table 1)	<u>9744</u>	=	_____
West Wall: (W) <u>8</u> (H) <u>8</u>	Heat Load (Table 1)	<u>9744</u>	=	_____
Floor: (U) <u>6</u> (W) <u>14</u> (H) <u>8</u>	Heat Load (Table 1)	<u>28000</u>	=	_____

2. Air Change Load

Volume 1792 cu.ft. x 1.2 Factor (Table 4) x 2.49 Factor (Table 6) 58007 = _____

3. Additional Loads

Electrical Motors: <u>0.1</u> HP x 75000 BTU/HP/24 hr.	<u>7500</u>	=	_____
Electrical Lights: <u>224</u> Watts x 82	<u>18368</u>	=	_____
People Load: <u>0</u> People x _____ BTU/24 hrs. (Table 12)	—	=	_____
Glass Door Load: <u>0</u> Doors x 19200 BTU/Door/24 hr.	—	=	_____

4. Product Load: Sensible (Product Load Figured @ 24 hr. Pulldown*)

(a) 1000 lbs./day x 0.77 Spec. Heat (Table 7) x _____ °F. Temp Drop 11550 = _____
 (b) _____ lbs./day x _____ Spec. Heat (Table 7) x _____ °F. Temp Drop _____ = _____
 *For product pulldown time other than 24 hrs. figure 24 hr. load x (24/Pulldown Time)

5. Product Load: Respiration*

(a) _____ lbs. stored x _____ BTU/lbs./24 hrs. (Table 8) _____ = _____
 (b) _____ lbs. stored x _____ BTU/lbs./24 hrs. (Table 8) _____ = _____

*For consideration of previously loaded product, a multiplier of (5) is normally applied to the daily product load (Line #4)

Total Refrigeration Load (1+2+3+4+5) BTU/24 hrs. 184673
 Add 10% Safety Factor 18467
 Total with Safety/Factor BTU/24 hrs. 203140

Divide by No. of Operating Hrs. (16) to obtain BTUH Cooling Requirement 12696

Equipment Selection

Condensing Unit	Unit Cooler	System Capacity
Qty. Model No.	Qty. Model No.	BTU/hr.



Refrigeration Load Estimate Form (for rooms above 32°F) Bulletin Above32-05

Estimate for: _____

Estimate by: _____

Date: _____

Basis for Estimate

Room Dimensions: Width _____ ft. Length _____ ft. Height _____ ft.
 Volume: (L) _____ x (W) _____ x (H) _____ = _____ cu. ft.
 Ambient Temp _____ °F. (Corrected for sun load) — Room Temp _____ °F. = _____ °F. T.D.

Note: Tables can be found in Engineering Manual, H-ENG-2

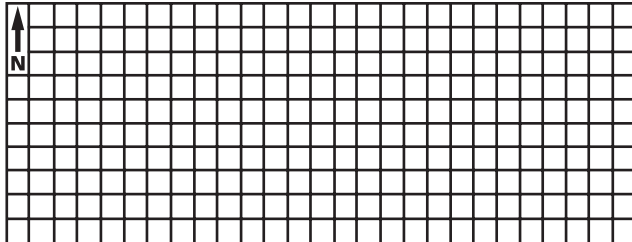

	Insulation	
	Inches	Type
Ceiling		
Walls		
Floor		

Product Load

(a) _____ lbs./day of _____ to be reduced from entering
 temp. of _____ °F. to _____ °F. Temp. Drop _____ °F.
 (b) _____ lbs./day of _____ to be reduced from entering
 temp. of _____ °F. to _____ °F. Temp. Drop _____ °F.

Miscellaneous

Motors (including all blower motors) _____ HP Ground Temp. _____ (Table 21)
 Lights (assume 1 watt/sq.ft.) _____ Watts
 No. of people _____

1. Transmission Loads

Ceiling: (L) _____ x (W) _____ x Heat Load _____ (Table 1) = _____
 North Wall: (L) _____ x (H) _____ x Heat Load _____ (Table 1) = _____
 South Wall: (L) _____ x (H) _____ x Heat Load _____ (Table 1) = _____
 East Wall: (W) _____ x (H) _____ x Heat Load _____ (Table 1) = _____
 West Wall: (W) _____ x (H) _____ x Heat Load _____ (Table 1) = _____
 Floor: (L) _____ x (W) _____ x Heat Load _____ (Table 1) = _____

2. Air Change Load

Volume: _____ cu. ft. x _____ Factor (Table 4) x _____ Factor (Table 6) = _____

3. Additional Loads

Electrical Motors: _____ HP x 75000 BTU/HP/24 hr. = _____
 Electrical Lights: _____ Watts x 82 = _____
 People Load: _____ People x _____ BTU/24 hrs. (Table 12) = _____
 Glass Door Load: _____ Doors x 19200 BTU/Door/24 hr. = _____

4. Product Load: Sensible (Product Load Figured @ 24 hr. Pulldown*)

(a) _____ lbs./day x _____ Spec. Heat (Table 7) x _____ °F. Temp Drop = _____
 (b) _____ lbs./day x _____ Spec. Heat (Table 7) x _____ °F. Temp Drop = _____
 *For product pulldown time other than 24 hrs. figure 24 hr. load x (24/Pulldown Time)

5. Product Load: Respiration*

(a) _____ lbs. stored x _____ BTU/lbs./24 hrs. (Table 8) = _____
 (b) _____ lbs. stored x _____ BTU/lbs./24 hrs. (Table 8) = _____
 *For consideration of previously loaded product, a multiplier of (5) is normally applied to the daily product load (Line #4)

Total Refrigeration Load (1+2+3+4+5) BTU/24 hrs. _____
 Add 10% Safety Factor _____
 Total with Safety/Factor BTU/24 hrs. _____
 Divide by No. of Operating Hrs. (16) to obtain BTUH Cooling Requirement _____

Equipment Selection

Condensing Unit	Unit Cooler	System Capacity
Qty. Model No.	Qty. Model No.	BTU/hr.



Refrigeration Load Estimate Form (for rooms below 32°F) Bulletin Below32-05

Estimate for:

Estimate by:

Date:

Example: -20°F Ice Cream Hardening Freezer

Basis for Estimate

Room Dimensions: Width 12 ft. Length 14 ft. Height 8 ft.

Volume: (L) 14 x (W) 12 x (H) 8 = 1344 cu. ft.

Ambient Temp 85 °F. (Corrected for sun load) — Room Temp. 105 °F. = _____ °F. T.D.

Note: Tables can be found in Engineering Manual, H-ENG-2

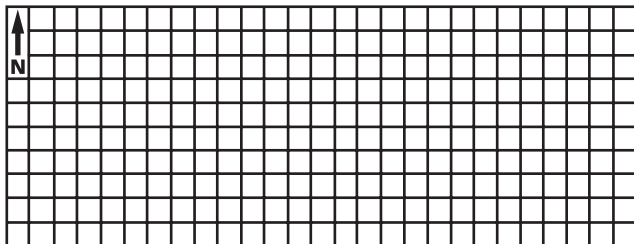

	Insulation	
	Inches	Type
Ceiling	4	Foamed In place Ure
Walls	4	Foamed In place Ure
Floor	4	Foamed In place Ure

Product Load

(a) _____ lbs./day of _____ to be reduced from entering temp. of _____ °F. to freezing point of _____ °F. (Table 7) = _____ °F. Initial temp. drop and then reduced from freezing point to storage Temp. of _____ °F. = (Table 7) _____ °F. Final temp. drop.
 (b) 100 gallons of ice cream @ _____ overrun

Miscellaneous

Motors (including all blower motors) 0.2 HP Ground Temp. _____ (Table 21)
 Lights (assume 1 watt/sq.ft.) 168 Watts
 No. of People 0

1. Transmission Loads

Ceiling: (L) <u>14</u> x <u>12</u> (W) x <u>8</u> (H) Heat Load _____ (Table 1)	12768	= _____
North Wall: (L) <u>14</u> x <u>8</u> (H) Heat Load _____ (Table 1)	8512	= _____
South Wall: (L) <u>14</u> x <u>8</u> (H) Heat Load _____ (Table 1)	8512	= _____
East Wall: (W) <u>2</u> x <u>8</u> (H) Heat Load _____ (Table 1)	7296	= _____
West Wall: (W) <u>2</u> x <u>8</u> (H) Heat Load _____ (Table 1)	7296	= _____
Floor: (L) <u>14</u> x <u>12</u> (W) Heat Load _____ (Table 1)	9744	= _____

2. Air Change Load

Volume: 1344 cu. ft. x _____ Factor (Table 5) x _____ Factor (Table 6) 56287 = _____

3. Additional Loads

Electrical Motors <u>0.2</u> HP x 75000 BTU/HP/24 hr.	15000	= _____
Electrical Lights: <u>168</u> Watts x 82	13776	= _____
People Load: <u>0</u> People x _____ BTU/24 hrs. (Table 12)	=	= _____
Glass Door Load <u>0</u> Doors x 31200 BTU/Door/24 hr.	=	= _____

4. Product Load: (Table 7) (Product Load Figured @ 24 hr. Pulldown*)

(a) _____ lbs./day x _____ Spec. Heat above freezing x _____ °F. Intial Temp. Drop	=	= _____
_____ lbs./day x _____ Latent Heat Fusion	=	= _____
_____ lbs./day x _____ Spec. Heat below freezing x _____ °F. Intial Temp. Drop	=	= _____
(b) <u>100</u> gallons of ice cream @ <u>125</u> BTU/gal (Table 8) Pull down)*	102000	= _____

*For product pulldown time other than 24 hrs. figure 24 hr. load x (24/Pulldown Time)

Total Refrigeration Load (1+2+3+4+5) BTU/24 hrs.	<u>241191</u>
Add 10% Safety Factor	<u>24119</u>
Total with Safety/Factor BTU/24 hrs.	<u>265310</u>
Divide by No. of Operating Hrs. (18) to obtain BTUH Cooling Requirement	<u>14739</u>

Equipment Selection

Condensing Unit	Unit Cooler	System Capacity
Qty. Model No.	Qty. Model No.	BTU/hr.



Refrigeration Load Estimate Form (for rooms below 32°F) Bulletin Below32-05

Estimate for:

Estimate by:

Date:

Example: -10°F Beef Freezer

Basis for Estimate

Room Dimensions: Width 20 ft. Length 24 ft. Height _____ ft.

Volume: (L) 24 x (W) 20 x (H) 12 = 5760 cu. ft.

Ambient Temp 90 °F. (Corrected for sun load) — Room Temp. 100 °F. = _____ °F. T.D.

Note: Tables can be found in Engineering Manual, H-ENG-2

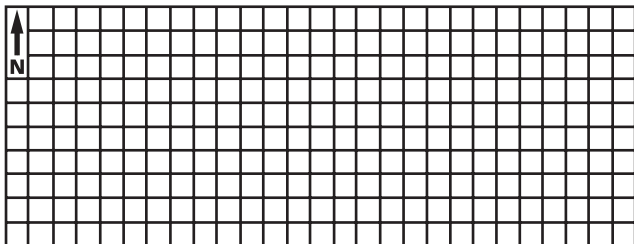

	Insulation	
	Inches	Type
Ceiling	4	Foamed In place Ure
Walls	4	Foamed In place Ure
Floor	4	Foamed In place Ure

Product Load

(a) 3000 lbs./day Beef to be reduced from entering temp 35 °F. to freezing point 28 °F. (Table 7) = _____ °F. Initial temp. drop and then reduced from freezing point to storage Temp. of -10 °F. = (Table 7) 38 °F. Final temp. drop.
 (b) _____ gallons of ice cream @ _____ overrun

Miscellaneous

Motors (including all blower motors) 0.5 HP Ground Temp. _____ (Table 21)
 Lights (assume 1 watt/sq.ft.) 480 Watts
 No. of People 0

1. Transmission Loads

Ceiling: (L) <u>24</u> x (W) <u>20</u>	x Heat Load _____ (Table 1)	<u>34560</u>	=	_____
North Wall: (L) <u>24</u> x (H) <u>12</u>	x Heat Load _____ (Table 1)	<u>20736</u>	=	_____
South Wall: (L) <u>24</u> x (H) <u>12</u>	x Heat Load _____ (Table 1)	<u>20736</u>	=	_____
East Wall: (W) <u>20</u> x (H) <u>12</u>	x Heat Load _____ (Table 1)	<u>17280</u>	=	_____
West Wall: (W) <u>20</u> x (H) <u>12</u>	x Heat Load _____ (Table 1)	<u>17280</u>	=	_____
Floor: (L) <u>24</u> x (W) <u>20</u>	x Heat Load _____ (Table 1)	<u>24000</u>	=	_____

2. Air Change Load

Volume: 5760 cu. ft. x _____ Factor (Table 5) x _____ Factor (Table 6) 106629 = _____

3. Additional Loads

Electrical Motors <u>0.5</u> HP x 75000 BTU/HP/24 hr.	<u>37500</u>	=	_____
Electrical Lights <u>480</u> Watts x 82	<u>39360</u>	=	_____
People Load: <u>0</u> People x _____ BTU/24 hrs. (Table 12)	—	=	_____
Glass Door Load <u>0</u> Doors x 31200 BTU/Door/24 hr.	—	=	_____

4. Product Load: (Table 7) (Product Load Figured @ 24 hr. Pulldown*)

(a) <u>3000</u> lbs./day x <u>0.77</u> Spec. Heat above freezing x _____ °F. Initial temp. Drop	<u>16170</u>	=	_____
<u>3000</u> lbs./day x <u>1.00</u> Latent Heat Fusion	<u>300000</u>	=	_____
<u>3000</u> lbs./day x <u>0.4</u> Spec. Heat below freezing x _____ °F. Initial temp. Drop	<u>45600</u>	=	_____
(b) _____ gallons of ice cream/day x _____ BTU/gal (Table 10) (Pull down)*	—	=	_____

*For product pulldown time other than 24 hrs. figure 24 hr. load x (24/Pulldown Time)

Total Refrigeration Load (1+2+3+4+5) BTU/24 hrs.	<u>679851</u>
Add 10% Safety Factor	<u>67985</u>
Total with Safety/Factor BTU/24 hrs.	<u>747836</u>
Divide by No. of Operating Hrs. (18) to obtain BTUH Cooling Requirement	<u>41546</u>

Equipment Selection

Condensing Unit	Unit Cooler	System Capacity
Qty. Model No.	Qty. Model No.	BTU/hr.



Refrigeration Load Estimate Form (for rooms below 32°F) Bulletin Below32-05

Estimate for: _____

Estimate by: _____

Date: _____

Basis for Estimate

Room Dimensions: Width _____ ft. Length _____ ft. Height _____ ft.
 Volume: (L) _____ x (W) _____ x (H) _____ = _____ cu. ft.
 Ambient Temp _____ °F. (Corrected for sun load) — Room Temp. _____ °F. = _____ °F. T.D.

Note: Tables can be found in Engineering Manual, H-ENG-2

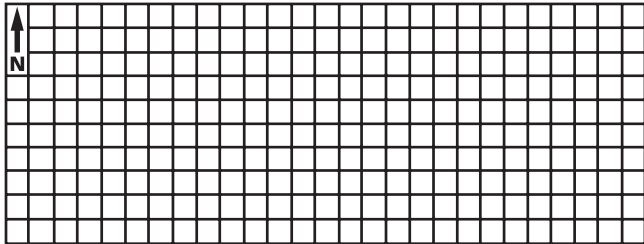

	Insulation	
	Inches	Type
Ceiling		
Walls		
Floor		

Product Load

(a) _____ lbs./day of _____ to be reduced from entering temp. of _____ °F. to freezing point of _____ °F. (Table 7) = _____ °F. Initial temp. drop and then reduced from freezing point to storage Temp. of _____ °F. = (Table 7) _____ °F. Final temp. drop.
 (b) _____ gallons of ice cream @ _____ overrun

Miscellaneous

Motors (including all blower motors) _____ HP Ground Temp. _____ (Table 21)
 Lights (assume 1 watt/sq.ft.) _____ Watts
 No. of People _____

1. Transmission Loads

Ceiling: (L) _____ x (W) _____ x Heat Load _____ (Table 1) = _____
 North Wall: (L) _____ x (H) _____ x Heat Load _____ (Table 1) = _____
 South Wall: (L) _____ x (H) _____ x Heat Load _____ (Table 1) = _____
 East Wall: (W) _____ x (H) _____ x Heat Load _____ (Table 1) = _____
 West Wall: (W) _____ x (H) _____ x Heat Load _____ (Table 1) = _____
 Floor: (L) _____ x (W) _____ x Heat Load _____ (Table 1) = _____

2. Air Change Load

Volume: _____ cu. ft. x _____ Factor (Table 5) x _____ Factor (Table 6) = _____

3. Additional Loads

Electrical Motors: _____ HP x 75000 BTU/HP/24 hr. = _____
 Electrical Lights: _____ Watts x 82 = _____
 People Load: _____ People x _____ BTU/24 hrs. (Table 12) = _____
 Glass Door Load: _____ Doors x 31200 BTU/Door/24 hr. = _____

4. Product Load: (Table 7) (Product Load Figured @ 24 hr. Pulldown*)

(a) _____ lbs./day x _____ Spec. Heat above freezing x _____ °F. Intial Temp. Drop = _____
 _____ lbs./day x _____ Latent Heat Fusion = _____
 _____ lbs./day x _____ Spec. Heat below freezing x _____ °F. Intial Temp. Drop = _____
 (b) _____ gallons of ice cream/day x _____ BTU/gal (Table 19) = _____

*For product pulldown time other than 24 hrs. figure 24 hr. load x (24/Pulldown Time)

Total Refrigeration Load (1+2+3+4+5) BTU/24 hrs. _____
 Add 10% Safety Factor _____
 Total with Safety/Factor BTU/24 hrs. _____

Divide by No. of Operating Hrs. (18) to obtain BTUH Cooling Requirement _____

Equipment Selection

Condensing Unit	Unit Cooler	System Capacity
Qty. Model No.	Qty. Model No.	BTU/hr.

Appendix - Tables

Table 1
Wall Heat Loads

Insulation (Inches)				R	Heat Load (BTU Per 24 Hours Per One Square Foot of Outside Surface)																	
Cork or Mineral Wool k = .30	Glass Fiber or Poly-Styrene k = .26	Urethane (Sprayed) k = .16	Urethane (Foamed in Place) k = .12		Temperature Reduction in °F. (Outside Air Temperature Minus Room Temperature)																	
					1	40	45	50	55	60	65	70	75	80	85	90	95	100	105	110	115	120
	1			4	5.10	204	230	255	281	306	332	357	383	408	434	459	485	510	536	561	587	612
	2			8	3.40	136	153	170	187	204	221	238	255	272	289	306	323	340	357	374	391	408
4	3	2		12.6	1.80	72	81	90	99	108	117	126	135	144	153	162	171	180	189	198	207	216
5	4		2	16.4	1.44	58	65	72	79	87	94	101	108	115	122	130	137	144	151	159	166	173
6	5	3		19.6	1.20	48	54	60	66	72	78	84	90	96	102	108	114	120	126	132	138	144
8	6	4	3	25	0.90	36	41	45	50	54	59	63	68	72	77	81	86	90	95	99	104	108
10	8		4	33	0.72	29	32	36	40	43	47	50	54	58	61	65	68	72	76	79	83	86
	10	6		38.7	0.60	24	27	30	33	36	39	42	45	48	51	54	57	60	63	66	69	72
			6	50	0.48	19	22	24	26	29	31	34	36	38	41	43	46	48	51	53	55	58
Single window glass				.9	27	1080	1215	1350	1490	1620	1760	1890	2030	2160	2290	2440	2560	2700	2840	2970	3100	3240
Double Window Glass				2.2	11	440	495	550	610	660	715	770	825	880	936	990	1050	1100	1160	1210	1270	1320
Triple Window Glass				3.4	7	280	315	350	390	420	454	490	525	560	595	630	665	700	740	770	810	840
6" Concrete Floor				4.8	5	200	225	250	275	300	325	350	375	400	425	450	475	500	525	550	575	600

Note: Above insulation "K" Factors [Thermal Conductivity, BTU per (hour) (square foot) (°F. per inch of thickness)] and heat gain factors for Cork and Window Glasses are extracted and

reprinted by permission from ASHRAE 1972 HANDBOOK OF FUNDAMENTALS.

Insulation Values

- "K" Factor - Insulating Value of any material is rated by its thermal conductivity
- "U" Factor - Overall coefficient of heat transfer, BTU per hour/per square foot/per degree F.
- "R" Factor - Thermal resistances
- "X" = Inches of Insulation

$K = UX = X/R$
$U = K/X = 1/R$
$R = 1/U = X/K$

Table 2
Effective K Factor in Block Thickness of Insulation

Insulation	Insul. K Factor	6"	8"	10"	12"
Air	4.65	6.94	6.65	6.50	6.40
Vermiculite	.47	2.73	2.67	2.64	2.62
Sawdust	.45	2.70	2.65	2.62	2.60
Cork	.38	2.62	2.57	2.55	2.53
Rock Wool	.30	2.52	2.49	2.47	2.45
Mac. Paper	.28	2.50	2.46	2.45	2.43
Styrofoam	.24	2.45	2.42	2.40	2.40
Polyurethane	.16	2.36	2.33	2.33	2.32

Note: If blocks have 3 holes, add .75 to all of the values shown. The above data is being shown for reference purpose only - this is a very inefficient method of construction/insulation due to:

1. Concrete webs are dominant factor in calculating insulating effect.
2. Filling techniques may leave blocks improperly filled.
3. No vapor seal present - moisture infiltration decreases insulation effect.
4. If used for freezers, moisture will freeze inside block and break out the surface of the block.
5. Blocks are highly subject to setting cracks- more infiltration.

Table 3
Allowance for Sun Effect

(Fahrenheit degrees to be added to the normal temperature difference for heat leakage calculations to compensate for sun effect- not to be used for air conditioning design.)

Type of Surface	East Wall	South Wall	West Wall	Flat Roof
Dark Colored Surfaces, Such as: Slate Roofing Tar Roofing Black Paints	8	5	8	20
Light Colored Surface, Such as: White Stone Light Colored Cement White Paint	4	2	4	9
Medium Colored Surface, Such as: Unpainted Wood Brick Red Tile Dark Cement Red, Gray or Green Paint	6	4	6	15

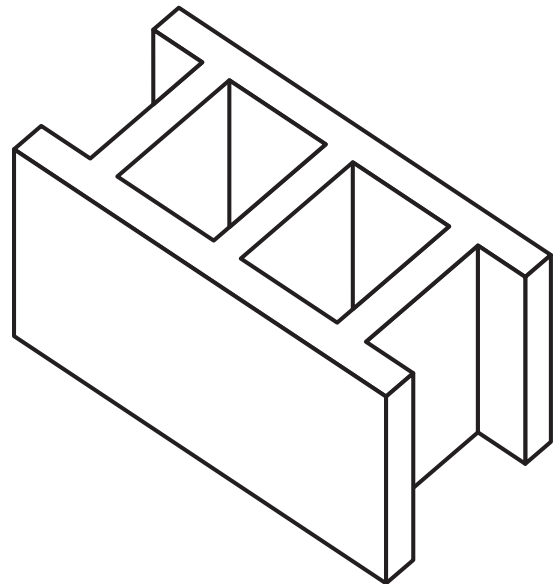

Table 4
Average air changes per 24 hours for storage rooms above 32°F. (0°C.) due to door openings and infiltration.

Volume Cu. Ft.	Air Changes Per 24hrs.	Volume Cu. Ft.	Air Changes Per 24hrs.	Volume Cu. Ft.	Air Changes Per 24hrs.
200	44.0	2,000	12.0	25,000	3.0
250	38.0	3,000	9.5	30,000	2.7
300	34.5	4,000	8.2	40,000	2.3
400	29.5	5,000	7.2	50,000	2.0
500	26.0	6,000	6.5	75,000	1.6
600	23.0	8,000	5.5	100,000	1.4
800	20.0	10,000	4.9	150,000	1.2
1,000	17.5	15,000	3.9	200,000	1.1
1,500	14.0	20,000	3.5	300,000	1.0

Note: For heavy usage multiply the above values by 2.0
For long storage multiply the above values by 0.6

Table 5
Average air changes per 24 hours for storage rooms below 32°F. (0°C.) due to door openings and infiltration.

Volume Cu. Ft.	Air Changes Per 24hrs.	Volume Cu. Ft.	Air Changes Per 24hrs.	Volume Cu. Ft.	Air Changes Per 24hrs.
200	33.5	2,000	9.3	25,000	2.3
250	29.0	3,000	7.4	30,000	2.1
300	26.2	4,000	6.3	40,000	1.8
400	22.5	5,000	5.6	50,000	1.6
500	20.0	6,000	5.0	75,000	1.3
600	18.0	8,000	4.3	100,000	1.1
800	15.3	10,000	3.8	150,000	1.0
1,000	13.5	15,000	3.0	200,000	0.9
1,500	11.0	20,000	2.6	300,000	0.85

Table 6
Heat removed in cooling air storage room conditions (BTU per Cu. Ft.)

Storage Room Temp.		Temperature of Outside Air											
		40°F. (4.4°C.)		50°F. (10°C.)		85°F. (29.4°C.)		90°F. (32.2°C.)		95°F. (35°C.)		100°F. (37.8°C.)	
		Relative Humidity of Outside Air, %											
°F.	°C.	70	80	70	80	50	60	50	60	50	60	50	60
55	12.8	-	-	-	-	1.12	1.34	1.41	1.66	1.72	2.01	2.06	2.44
50	10.0	-	-	-	-	1.32	1.54	1.62	1.87	1.93	2.22	2.28	2.65
45	7.2	-	-	-	-	1.50	1.73	1.80	2.06	2.12	2.42	2.47	2.85
40	4.4	-	-	-	-	1.69	1.92	2.00	2.26	2.31	2.62	2.67	3.65
35	1.7	-	-	0.36	0.41	1.86	2.09	2.17	2.43	2.49	2.79	2.85	3.24
30	-1.1	0.24	0.29	0.58	0.66	2.00	2.24	2.26	2.53	2.64	2.94	2.95	3.35
25	-3.9	0.41	0.45	0.75	0.83	2.09	2.42	2.44	2.71	2.79	3.16	3.14	3.54
20	-6.7	0.56	0.61	0.91	0.99	2.27	2.61	2.62	2.90	2.97	3.35	3.33	3.73
15	-9.4	0.71	0.75	1.06	1.14	2.45	2.74	2.80	3.07	3.16	3.54	3.51	3.92
10	-12.2	0.85	0.89	1.19	1.27	2.57	2.87	2.93	3.20	3.29	3.66	3.64	4.04
5	-15.0	0.98	1.03	1.34	1.42	2.76	3.07	3.12	3.40	3.48	3.87	3.84	4.27
0	-17.8	1.12	1.17	1.48	1.56	2.92	3.23	3.28	3.56	3.64	4.03	4.01	4.43
-5	-20.6	1.23	1.28	1.59	1.67	3.04	3.36	3.41	3.69	3.78	4.18	4.15	4.57
-10	-23.3	1.35	1.41	1.73	1.81	3.19	3.49	3.56	3.85	3.93	4.33	4.31	4.74
-15	-26.1	1.50	1.53	1.85	1.92	3.29	3.60	3.67	3.96	4.05	4.46	4.42	4.86
-20	-28.9	1.63	1.68	2.01	2.00	3.49	3.72	3.88	4.18	4.27	4.69	4.66	5.10
-25	-31.7	1.77	1.80	2.12	2.21	3.61	3.84	4.00	4.30	4.39	4.80	4.78	5.21
-30	-34.4	1.90	1.95	2.29	2.38	3.86	4.05	4.21	4.51	4.56	5.00	4.90	5.44

Table 3, 4 & 5 extracted and reprinted by permission from ASHRAE 1972 Handbook of Fundamentals.

Table 6 extracted and reprinted by permission from ASHRAE 1967 Handbook of Fundamentals.

Table 7
Storage requirements and properties of perishable products

Commodity (Alphabetical Listing)	Storage Conditions			Highest Freezing Point °F.	Specific Heat Above Freezing BTU/lb./F	Specific Heat Below Freezing BTU/lb./F	Latent Heat of Fusion BTU/lb.	Product Loading Density Approx. lb./Cu. Ft.
	Storage Temp. °F.	Relative Humidity %	Approximate Storage Life*					
Apples	30 - 40	90	3 - 8 months	29.3	0.87	0.45	121	28
Apricots	31 - 32	90	1 - 2 weeks	30.1	0.88	0.46	122	30
Artichokes (Globe)	31 - 32	95	2 weeks	29.9	0.87	0.45	120	—
Asparagus	32 - 36	95	2 - 3 weeks	30.9	0.94	0.48	134	25
Avocados	45 - 55	85 - 90	2 - 4 weeks	31.5	0.72	0.40	94	19
Bananas	55 - 65	85 - 90	—	30.6	0.80	0.42	108	—
Beans (Green or Snap)	40 - 45	90 - 95	7 - 10 days	30.7	0.91	0.47	128	14
Lima	32 - 40	90	1 week	31.0	0.73	0.40	94	—
Beer, Keg	35 - 40	—	3 - 8 weeks	28.0	0.92	—	129	—
Bottles, Cans	35 - 40	65 or below	3 - 6 months	28.0	0.92	—	129	—
Beets, Topped	32	95 - 100	4 - 6 months	30.1	0.90	0.46	126	23
Blackberries	31 - 32	95	3 days	30.5	0.88	0.46	122	19
Blueberries	31 - 32	90 - 95	2 weeks	29.7	0.86	0.45	118	19
Bread, Baked	—	—	1 - 3 months	16 to 20	0.70	0.34	46 - 53	—
Dough	35 - 40	85 - 90	3 - 72 hours	—	0.75	—	—	—
Broccoli, Sprouting	32	95	10 - 14 days	29.0	0.92	0.47	130	13
Brussels Sprouts	32	95	3 - 5 weeks	30.5	0.88	0.46	122	—
Cabbage	32	95 - 100	3 - 4 months	30.4	0.94	0.47	132	17
Carrots, Topped, Mature	32	98 - 100	5 - 9 months	29.5	0.90	0.46	126	22
Cauliflower	32	95	2 - 4 weeks	29.0	0.93	0.47	132	16
Celery	32	95	1 - 2 months	31.1	0.95	0.48	135	30
Cherries, Sour	31 - 32	90 - 95	3 - 7 days	29.0	0.87	—	120	18
Sweet	30 - 31	90 - 95	2 - 3 weeks	28.8	0.84	—	—	—
Chocolate (Coating)	50 - 65	40 - 50	2 - 3 months	95 - 85	0.55	0.30	40	—
Cocoa	32 - 40	50 - 70	1 year, plus	—	—	—	—	—
Coconut	32 - 45	80 - 85	1 - 2 months	30.4	0.58	0.34	67	—
Coffee (Green)	35 - 37	80 - 85	2 - 4 months	—	0.30	0.24	147 - 21	—
Collards	32	95	10 - 14 days	30.6	0.90	—	—	—
Corn, Sweet (Fresh)	32	95	4 - 8 days	30.9	0.79	0.42	106	16
Cranberries	36 - 40	90 - 95	2 - 4 months	30.4	0.90	0.46	124	22
Cucumbers	50 - 55	90 - 95	10 - 14 days	31.1	0.97	0.49	137	20
Currants	31 - 32	90 - 95	10 - 14 days	30.2	0.88	0.45	120	—
Daily Products								
Cheddar Cheese	40	65 - 70	6 months	8.0	0.50	0.31	53	40
Processed Cheese	40	65 - 70	12 months	19.0	0.50	0.31	56	40
Butter	40	75 - 85	1 months	-4 to 31	0.50	0.25	23	—
Cream	35 - 40	—	2 - 3 weeks	31.0	0.66 - 0.80	0.36 - 0.42	79 - 107	—
Ice Cream	-20 to -15	—	3 - 12 months	21.0	0.66 - 0.70	0.37 - 0.39	86	25
Milk, Fluid Whole								
Pasteurized, Grade A	32 - 34	—	2 - 4 months	31.0	0.93	0.46	125	—
Condensed Sweet	40	—	15 months	5.0	0.42	0.28	40	—
Evaporated	40	—	24 months	29.5	0.79	0.42	106	—
Dates (Dried)	0 or 32	75 or less	6 - 12 months	3.7	0.36	0.26	29	24
Dewberries	31 - 32	90 - 95	3 days	27.0	0.88	—	—	—
Dried Fruits	32	50 - 60	9 - 12 months	—	0.31 - 0.41	0.26	20 - 37	45
Eggplant	45 - 50	90 - 95	7 - 10 days	30.6	0.94	0.48	132	—
Egg, Shell	29 - 31	80 - 85	5 - 6 months	28.0	0.73	0.40	96	19
Shell, Farm Cooler	50 - 55	70 - 75	2 - 3 weeks	28.0	0.73	0.40	96	19
Frozen, Whole	0 or below	—	1 year, plus	28.0	0.73	0.42	106	41
Endive (Escarole)	32	95	2 - 3 weeks	31.9	0.94	0.48	132	—
Figs, Dried	32 - 40	50 - 60	9 - 12 months	—	0.39	0.27	34	45
Fresh	31 - 32	85 - 90	7 - 10 says	27.6	0.82	0.43	112	21
Fish, Fresh	30 - 35	90 - 95	5 - 15 days	28.0	0.70 - 0.86	0.38 - 0.45	89 - 112	—
Haddock, Cod	30 - 35	90 - 95	15 days	28	0.82	0.43	112	35
Salmon	30 - 35	90 - 95	15 days	28	0.71	0.39	92	33
Smoked	40 - 50	50 - 60	6 - 8 months	—	0.70	0.39	92	—
Shellfish, Fresh	30 - 33	86 - 95	3 - 7 days	28.0	0.83 - 0.90	0.44 - 0.46	113 - 125	—
Tuna	30 - 35	90 - 95	15 days	28.0	0.76	0.41	100	35
Furs and Fabric	34 - 40	45 - 55	several years	—	—	—	—	—
Garlic, Dry	32	65 - 70	6 - 7 months	30.5	0.69	0.40	89	—
Gooseberries	31 - 32	90 - 95	2 - 4 weeks	30.0	0.90	0.46	126	19
Grapefruit	50 - 60	85 - 90	4 - 6 weeks	30.0	0.91	0.46	126	30
Grapes, American Type	31 - 32	85 - 90	2 - 8 weeks	29.7	0.86	0.44	116	29
European Type	30 - 31	90 - 95	3 - 6 months	28.1	0.86	0.44	116	29
Greens, Leafy	32	95	10 - 14 days	30.0	0.91	0.48	136	32
Guavas	45 - 50	90	2 - 3 weeks	—	0.86	—	—	—
Honey	38 - 50	50 - 60	1 year, plus	—	0.35	0.26	26	—
Horseradish	30 - 32	95 - 100	10 - 12 months	28.7	0.78	0.42	104	—
Kale	32	95	3 - 4 months	31.1	0.89	0.46	124	—
Kohlrabi	32	95	2 - 4 weeks	30.2	0.92	0.47	128	—
Leeks, Green	32	95	1 - 3 months	30.7	0.88	0.46	126	—
Lemons	32 or 50 - 58	85 - 90	1 - 6 months	29.4	0.91	0.46	127	33
Lettuce Head	32 - 34	95 - 100	2 - 3 weeks	31.7	0.96	0.48	136	25
Limes 48 - 50	85 - 90	6 - 8 weeks	29.1	0.89	0.46	122	32	—

* Not based on maintaining nutritional value.

Reprinted by permission from 1974 ASHRAE Applications Handbook.

Table 7 Continued

Commodity (Alphabetical Listing)	Storage Conditions			Highest Freezing Point °F.	Specific Heat Above Freezing BTU/lb./°F	Specific Heat Below Freezing BTU/lb./°F	Latent Heat of Fusion BTU/lb.	Product Loading Density Approx. lb./Cu. Ft.
	Storage Temp. °F.	Relative Humidity %	Approximate Storage Life*					
Maple Sugar	75 - 80	60 - 65	1 year, plus	—	0.24	0.21	7	—
Mangoes	55	85 - 90	2 - 3 weeks	30.3	0.85	0.44	117	—
Meat								
Bacon, Cured (Farm Style)	60 - 65	85	4 - 6 months	—	0.30 - 0.43	0.24 - 0.29	18 - 41	57
Game, Fresh	32	80 - 85	1 - 6 weeks	28 - 29	0.80	0.42	115	—
Beef, Fresh	32 - 34	88 - 92	1 - 6 weeks	28 - 29	0.70 - 0.84	0.38 - 0.43	89 - 110	—
Hams and Shoulders, Fresh	32 - 34	85 - 90	7 - 12 days	28 - 29	0.58 - 0.63	0.34 - 0.36	67 - 77	37
Cured	60 - 65	50 - 60	0 - 3 years	—	0.52 - 0.56	0.32 - 0.33	57 - 64	—
Lamb Fresh	32 - 34	85 - 90	5 - 12 days	28 - 29	0.68 - 0.76	0.38 - 0.51	86 - 100	—
Livers, Frozen	-10 - 0	90 - 95	3 - 4 months	—	—	0.41	100	—
Pork, Fresh	32 - 34	85 - 90	3 - 7 days	28 - 29	0.46 - 0.55	0.30 - 0.33	46 - 63	—
Smoked Sausage	40 - 45	85 - 90	6 months	—	0.68	0.38	86	—
Fresh	32	85 - 90	1 - 2 weeks	26.0	0.89	0.56	93	—
Veal, Fresh	32 - 34	90 - 95	5 - 10 days	28 - 29	0.71 - 0.76	0.39 - 0.41	92 - 100	—
Melons, Cantaloupe	36 - 40	90 - 95	5 - 15 days	29.9	0.93	0.48	132	25
Honeydew and Honey Ball	45 - 50	90 - 95	3 - 4 weeks	30.3	0.94	0.48	132	24
Watermelons	40 - 50	80 - 90	2 - 3 weeks	31.3	0.97	0.48	132	27
Mushrooms	32	90	3 - 4 days	30.4	0.93	0.47	130	—
Milk	34 - 40	—	7 days	31	0.93	0.49	124	64
Nectarines	31 - 32	90	2 - 4 weeks	30.4	0.90	0.49	119	—
Nuts (dried)	32 - 50	65 - 75	8 - 12 months	—	0.22 - 0.25	0.21 - 0.22	4 - 8	25
Okra	45 - 50	90 - 95	7 - 10 days	28.7	0.92	0.46	128	—
Oleomargarine	35	60 - 70	1 year, plus	—	0.38	0.25	22	—
Olives, Fresh	45 - 50	85 - 90	4 - 6 weeks	29.4	0.80	0.42	108	—
Onions (Dry) and Onion Sets	32	65 - 70	1 - 8 months	30.6	0.90	0.46	124	—
Green	32	95	3 - 4 weeks	30.4	0.91	—	—	22
Oranges	32 - 48	85 - 90	3 - 12 weeks	30.6	0.90	0.46	124	34
Orange Juice, Chilled	30 - 35	—	3 - 6 weeks	—	0.91	0.47	128	—
Papayas	45	85 - 90	1 - 3 weeks	30.4	0.82	0.47	130	—
Parsley	32	95	1 - 2 months	30.0	0.88	0.45	122	—
Parsnip	32	98 - 100	4 - 6 months	30.4	0.84	0.44	112	36
Peaches and Nectarines	31 - 32	90	2 - 4 weeks	30.3	0.90	0.46	124	33
Pears	29 - 31	90 - 95	2 - 7 months	29.2	0.86	0.45	118	47
Peas, Green	32	95	1 - 3 weeks	30.9	0.79	0.42	106	23
Peppers, Sweet	45 - 50	90 - 95	2 - 3 weeks	30.7	0.94	0.47	132	41
Peppers, Chili (Dry)	32 - 50	60 - 70	6 months	—	0.30	0.24	17	—
Persimmons	30	90	3 - 4 months	28.1	0.84	0.43	112	—
Pineapples, Ripe	45	85 - 90	2 - 4 weeks	30.0	0.88	0.45	122	25
Plums, Including Fresh Prunes	31 - 32	90 - 95	2 - 4 weeks	30.5	0.88	0.45	118	22
Pomegranates	32	90	2 - 4 weeks	26.6	0.87	0.48	112	—
Popcorn, Unopened	32 - 40	85	4 - 6 months	—	0.31	0.24	19	—
Potatoes, Early Crop	50 - 55	90	0 - 2 months	30.9	0.85	0.44	116	42
Late Crop	38 - 50	90	5 - 8 months	30.9	0.82	0.43	111	—
Poultry, Fresh Chicken	32	85 - 90	1 week	27.0	0.79	0.42	106	38
Fresh Goose	32	85 - 90	1 week	27.0	0.57	0.34	67	—
Fresh Turkey	32	85 - 90	1 week	27.0	0.64	0.37	79	25
Pumpkins	50 - 55	70 - 75	2 - 3 months	30.5	0.92	0.47	130	—
Quinces	31 - 32	90	2 - 3 months	28.4	0.88	0.45	122	—
Radishes- Spring, Prepacked	32	95	3 - 4 weeks	30.7	0.95	0.48	134	—
Raisins (Dried)	40	60 - 70	9 - 12 months	—	0.47	0.32	43	45
Rabbits, Fresh	32 - 34	90 - 95	1 - 5 days	—	0.74	0.40	98	22
Raspberries, Black	31 - 32	90 - 95	2 - 3 days	30.0	0.84	0.44	122	—
Red	31 - 32	90 - 95	2 - 3 days	30.9	0.87	0.45	121	—
Rhubarb	32	95	2 - 4 weeks	30.3	0.96	0.48	134	—
Rutabagas	32	98 - 100	4 - 6 moths	30.1	0.91	0.47	127	—
Salsify	32	98 - 100	2 - 4 months	30.0	0.83	0.44	113	—
Spinach	32	95	10 - 14 days	31.5	0.94	0.48	132	31
Squash, Summer	32 - 50	85 - 95	5 - 14 days	31.1	0.95	0.48	135	—
Winter	50 - 55	70 - 75	4 - 6 months	30.3	0.91	0.48	127	—
Strawberries, Fresh	31 - 32	90 - 95	5 - 7 days	30.6	0.92	0.42	129	40
Sugar, Maple	75 - 80	60 - 65	1 year, plus	—	0.24	0.21	7	—
Sweet Potatoes	55 - 60	85 - 90	4 - 7 months	29.7	0.75	0.40	97	25
Syrup, Maple	31	60 - 70	1 year, plus	—	0.48	0.31	51	—
Tangerines	32 - 38	85 - 90	2 - 4 weeks	30.1	0.90	0.46	125	—
Tobacco, Cigarettes	35 - 46	50 - 56	6 months	25.0	—	—	—	—
Cigars	35 - 50	60 - 65	2 months	25.0	—	—	—	—
Tomatoes, Mature Green	55 - 70	85 - 90	1 - 3 weeks	31.0	0.95	0.48	134	25
Firm Ripe	45 - 50	85 - 90	4 - 7 days	31.1	0.94	0.48	134	21
Turnips, Roots	32	95	4 - 5 months	30.1	0.93	0.47	130	—
Vegetables (Mixed)	32 - 40	90 - 95	1 - 4 weeks	30.0	0.90	0.45	130	25
Yams	60	85 - 90	3 - 6 months	28.5	0.79	0.40	105	—
Yeast, Compressed Baker's	31 - 32	—	—	—	0.77	0.41	102	—

* Not based on maintaining nutritional value.

Table 8
Heat of Respiration (Approx.)

BTU / LB. / 24 Hrs.				
Storage Temperature Degree F.				
Product	32°F.	40°F.	60°F.	°F. Other
FRUITS				
Apples	0.25 - 0.45	0.55 - 0.80	1.50 - 3.40	
Apricots	0.55 - 0.63	0.70 - 1.00	2.33 - 3.74	
Avocados	—	—	6.60 - 15.35	
Bananas	—	—	2.30 - 2.75	@ 68° 4.2 - 4.6
Blackberries	1.70 - 2.52	5.91 - 5.00	7.71 - 15.97	
Blueberries	0.65 - 1.10	1.00 - 1.35	3.75 - 6.50	@ 70° 5.7 - 7.5
Cherries	0.65 - 0.90	1.40 - 1.45	5.50 - 6.60	
Cherries, Sour	0.63 - 1.44	1.41 - 1.45	3.00 - 5.49	
Cranberries	0.30 - 0.35	0.45 - 0.50	—	
Figs, Mission	—	1.18 - 1.45	2.37 - 3.52	
Gooseberries	0.74 - 0.96	1.33 - 1.48	2.37 - 3.52	
Grapefruit	0.20 - 0.50	0.35 - 0.65	1.10 - 2.00	
Grapes - American	0.30	0.60	1.75	
Grapes - European	0.15 - 0.20	0.35 - 0.65	1.10 - 1.30	
Lemons	0.25 - 0.45	0.30 - 0.95	1.15 - 2.50	
Limes	—	0.45	1.485	
Melons - Cantaloupe	0.55 - 0.63	0.96 - 1.11	3.70 - 4.22	
Melons - Honey Dew	—	0.45 - 0.55	1.20 - 1.65	
Oranges	0.22 - 0.50	0.65 - 0.80	1.85 - 2.60	
Peaches	0.45 - 0.70	0.70 - 1.00	3.65 - 4.65	
Pears	0.35 - 0.45	2.20	4.40 - 6.60	
Plums	0.20 - 0.35	0.45 - 0.75	1.20 - 1.40	
Raspberries	1.95 - 2.75	3.40 - 4.25	9.05 - 11.15	
Strawberries	1.35 - 1.90	1.80 - 3.40	7.80 - 10.15	
Tangerines	1.63	2.93	—	
VEGETABLES				
Artichokes (Globe)	2.48 - 4.93	3.48 - 6.56	8.49 - 15.90	
Asparagus	2.95 - 6.60	5.85 - 11.55	11.00 - 25.75	
Beans, Green or Snap	—	4.60 - 5.70	16.05 - 22.05	
Beans, Lima	1.15 - 1.60	2.15 - 3.05	11.00 - 13.70	
Beets, Topped	1.35	2.05	3.60	
Broccoli	3.75	5.50 - 8.80	16.90 - 25.00	
Brussels Sprouts	1.65 - 4.15	3.30 - 5.50	6.60 - 13.75	
Cabbage	0.60	0.85	2.05	
Carrots, Topped	1.05	1.75	4.05	
Cauliflower	1.80 - 2.10	2.10 - 2.40	4.70 - 5.40	
Celery	0.80	1.20	4.10	
Corn, Sweet	3.60 - 5.65	5.30 - 6.60	19.20	
Cucumber	—	—	1.65 - 3.65	
Garlic	0.33 - 1.19	0.63 - 1.08	1.18 - 3.00	
Horseradish	0.89	1.19	3.59	
Kohlrabi	1.11	1.78	5.37	
Leeks	1.04 - 1.78	2.15 - 3.19	9.08 - 12.82	
Lettuce, Head	1.15	1.35	3.95	
Lettuce, Leaf	2.25	3.20	7.20	
Mushrooms	3.10	7.80	—	@ 50° 11.0
Okra	—	6.05	15.8	
Olives	—	—	2.37 - 4.26	
Onions, Dry	0.35 - 0.55	0.90	1.20	
Onions, Green	1.15 - 2.45	3.00 - 7.50	7.25 - 10.70	
Peas, Green	4.10 - 4.20	6.60 - 8.00	19.65 - 22.25	
Peppers, Sweet	1.35	2.35	4.25	
Potatoes, Immature	—	1.30	1.45 - 3.40	
Potatoes, Mature	—	0.65 - 0.90	0.75 - 1.30	
Potatoes, Sweet	—	0.85	2.15 - 3.15	
Radishes with Top	1.59 - 1.89	2.11 - 2.30	7.67 - 8.50	
Radishes, Topped	0.59 - 0.63	0.85 - 0.89	3.04 - 3.59	
Rhubarb, Topped	0.89 - 1.44	1.19 - 2.00	3.41 - 4.97	
Spinach	2.10 - 2.45	3.95 - 5.60	18.45 - 19.00	
Squash Yellow	1.30 - 1.41	1.55 - 2.04	8.23 - 9.97	
Tomatoes, Mature Green	—	0.55	3.10	
Tomatoes, Ripe	0.50	0.65	2.80	
Turnips	0.95	1.10	2.65	
Vegetables, Mixed	2.00	4.00	—	
MISCELLANEOUS				
Caviar, Tub	—	—	1.91	
Cheese, American	—	—	2.34	
Camembert	—	—	2.46	
Limburger	—	—	2.46	
Roquefort	—	—	—	@ 45° 2.0
Swiss	—	—	2.33	
Flowers, Cut		0.24 BTU / 24 Hrs. / Sq. Ft. Floor Area		

Table 9
Heat Loads of Keg and Bottled Beer (BTU / 24 HR)

Type and Size of Container	Temperature Reduction of Beer only. °F.							
	60	50	40	30	20	15	10	5
Wood								
One Keg	—	—	12000	9000	6000	4500	3000	1500
Half Keg	—	—	5600	4650	3100	2325	1550	775
Quarter Keg	—	—	3200	2400	1600	1200	800	400
Eighth Keg	—	—	1640	1230	820	615	410	205
Aluminum								
Half Keg	—	—	5200	3900	2600	1950	1300	650
Quarter Keg	—	—	2560	1920	1280	960	640	320
Eighth Keg	—	—	1400	1050	700	525	350	175
Steel								
Half Keg	—	—	4800	3600	2600	1800	1200	600
Quarter Keg	—	—	2400	1800	1200	900	600	300
Bottles								
6 oz.	32	27	22	16	10.8	8.1	5.4	2.7
7 oz.	37	31	25	20	124	9.3	6.2	3.1
8 oz.	42	35	28	21	14.0	10.5	7.0	3.5
9 oz.	47	38	30	23	15.2	11.4	7.6	3.8
12 oz.	60	50	40	30	20	15	10	5.0
Cases of 24 - 12 oz. Bottles/Cans	1920	1600	1280	960	640	480	320	160

Table 10
Carcass Weight

Carcass	Average Weight lbs.	Specific Heat	Entering Carcass Temp. °F.	Final Carcass Temp. °F.
Cattle	550	0.77	106	35
Calves	150	0.76	104	35
Sheep	45	0.76	101	33
Hogs	180	0.54	106	35

Table 11
Heat equivalent of electric motors

Motor HP	BTU per (HP) (HR)		
	Connected Load In Refr Space ¹	Motor Losses Outside Refr Space ²	Connected Load Outside Refr Space ³
	1/8 to 1/2	4,250	2,545
1/2 to 3	3,700	2,545	1,150
3 to 20	2,950	2,545	400

¹ For use when both useful output and motor losses are dissipated within refrigerator space: motors driving fans for forced circulation unit coolers.
² For use when motor losses are dissipated outside refrigerated space and useful work of motor is expended within refrigerated space: pump on a circulating brine or chilled water system, fan motor outside refrigerated space driving fan circulating air within refrigerated space.
³ For use when motor heat losses are dissipated within refrigerated space and useful work expended outside of refrigerated space: motor in refrigerated space driving pump or fan located outside of space.

Table 12
Heat equivalent of Occupancy

Cooler Temperature °F.	Heat Equivalent / Person BTU / 24 Hrs.
50	17,280
40	20,160
30	22,800
20	25,200
10	28,800
0	31,200
-10	33,600

Table 13
General standard for insulation thickness in storage rooms

Storage Temperature		Desirable Insulation Thickness in Inches	
°F.	°C.	Styrofoam	Urethane
-50° to -25°	-45° to -32°	8	6
-25° to -0°	-32° to -18°	6	4
0° to 25°	-18° to -4°	4	4
25° to 40°	-4° to 5°	4	3 - 4
40° and up	+5° and up	2	2

Table 14
Heat gain due to operation of battery operated lift truck

Battery operated load capacity lb.	Heat Gain per hour of truck operation BTU / hr.*	Approximate total weight of lift truck lb.
2,000	14,000	6,000
4,000	21,000	8,000
6,000	23,000	12,000
8,000	26,000	14,000

* Heat gain from lift trucks with internal combustion engines can be approximated by multiplying the engine horsepower by 2,545 by the number of hours of operation (BTU/24 Hrs.)

Table 15
Specific heats of various liquids and solids

Name	Specific Heat	
	BTU/lb./°F.	Temp °F.
Liquids		
Acetic Acid	0.522	79 - 203
Alcohol-Ethyl	0.680	32 - 208
Alcohol-Methyl	0.610	59 - 68
Calcium Chloride		
Brine (20% by wt.)	0.744	68
Carbon		
Tetrachloride	0.201	68
Chloroform	0.234	68
Gasoline	0.500	32 - 212
Glycerine	0.575	59 - 120
Olive Oil	0.471	44
Toluene	0.404	68
Turpentine	0.420	68
Solids		
Aluminum	0.214	—
Asphalt	0.220	—
Bakelite	0.350	—
Brickwork	0.200	—
Brass	0.090	—
Bronze	0.104	—
Concrete	0.156	—
Glass	0.200	—
Ice	0.465	-4
Ice	0.487	32
Iron (Cast)	0.120	—
Lead	0.031	—
Paper	0.320	—
Porcelain	0.180	—
Rubber Goods	0.480	—
Sand	0.191	—
Steel	0.120	—
Woods		
Fir 0.650	—	—
Oak	0.570	—
Pine	0.670	—

Banana Ripening Room

Banana hands or cluster shipped greens in fiberboard cartons, 10" x 16" x 22", holding 42 lb. net (47 lbs. gross weight) with 864 boxes (3,288) lbs, net in a carload lot. Temperature held 56 to 58°F.

Ripening facility consists of 5 or more air tight rooms to permit a completely weekly turn-over (1/2 carload room, measuring 30' x 6' x 22'H outside, holds 432 boxes packed, 24 boxes each on 18 pallets stacked 3 high by 6 long). Ripening process started with ethylene gas and ripening schedules maintained by control of room temperatures.

Heating is provided to bring the load up to temperature before ripening process is initiated. 12 to 20 Kw per carload. (Electric heater sheath temperature not over 600°F. in dead still air).

Evaporators are selected at a T.D. of 15°F, or less, with evaporator temperature controlled at no less than 40°F. Approximately 12.5 cfm at 2/3" to 3/4" static per 41 lb. box of bananas.

Pull down load for 1°F/hr. pull down rate based on maximum heat of respiration of 2.5 BTU/lb. and 0.8 sp. ht. for bananas and 0.4 for fiberboard boxing, plus minimal wall losses etc., 80 to 85 BTU/hr./box of bananas. Holding load approximately 44 BTU/hr./box.

Extracted from ASHRAE 1974 APPLICATION HANDBOOK.

Loading: 5.3 lbs./Cu. Ft. of box, 11.28 lbs. net per pallet

Table 16
Banana Rooms – Refrigeration Requirements

Room Size	Number Boxes Prod.	Evaporator BTU Per 10° TD	Approx. CFM Air Volume	Elect. Heat Input
1/2 Car	432	36000	6000	6Kw
1 Car	864	72000	12000	12Kw
2 Car	1728	144000	24000	24Kw

Table 17
Meat Cutting/Prep Room Load (BTU/HR/SQ FT of floor area)

Floor SQ FT	Approx. 65% R.H. Room Temp.		Room Loads based on continuous operation and includes allowance for average number of personnel, processing equipment, etc., with glass panel in one wall and walls and ceiling insulated with 3" of styrene with box located in air conditioned area. Evaporator should be low outlet velocity type to avoid drafts and should be selected for continuous operation and not less than 30°F. evap. temp.
	55°F.	50°F.	
100	93	105	
200	88	99	
300	85	95	
400	81	90	
500	78	87	
600	75	85	
700	72	81	
800	69	78	
900	67	75	
1000	65	73	
1200	62	69	

Table 18
Rapid load selection for back bars
(Based on 2" glass fiber or equivalent insulation and 50°F, T.D.)

Back Bar Length in feet	BTU/Hour Load Based on 16 Hour Compressor Operation
6 Feet	1,060
8 Feet	1,416
10 Feet	1,770
12 Feet	2,120
15 Feet	2,650
20 Feet	3,540

Table 19
Refrigeration requirements for hardening ice cream

Overrun Percent	Hardening Load, BTU per Gal. Ice Cream
60	532
70	500
80	470
90	447
100	425
110	405
120	386

$$\text{Percentage overrun} = 100 \times \frac{\text{Wt. per gal. of mix} - \text{Wt. per gal. of ice cream}}{\text{Wt. per gal. of ice cream}}$$

Ice cream assumed at 25°F., and 30% frozen, entering hardening room.

To retain a smooth texture in hardened ice cream, it is necessary to freeze the remaining water content rapidly. With forced air circulation, time to harden will be about 10 hours with room maintained at -20. Hardening rooms are usually sized to allow for minimum of 3 times the daily peak production and for a stock of all flavors with the size based on 10 gallons per sq. ft. stacked solid 6 ft. high, including space for aisles.

Reprinted by permission from
ASHRAE 1974 APPLICATION HANDBOOK

Table 20
Glass Door Loads

Box Temperature	BTU per Door
+35	1060
+30	960
0	1730
-10	1730
-20	1730

* Adjusted for 16-18 hour run time. Multiply number of doors times door load above and add to box load.

Table 21
Summer outside air and ground temperature design conditions

State	City	Design Dry Bulb		Design Wet Bulb		Ground Temp.	
		°F.	°C.	°F.	°C.	°F.	°C.
Alabama	Birmingham	95	35	78	26	70	21
	Mobile	95	35	80	27	75	24
Alaska	Fairbanks	82	28	64	18	40	4
Arizona	Phoenix	105	41	76	24	80	27
	Tucson	105	41	72	22	80	27
	Yuma	110	43	78	26	80	27
Arkansas	Little Rock	95	35	78	26	70	21
California	Bakersfield	105	41	70	21	75	24
	Fresno	105	41	74	23	80	27
	Los Angeles	85	29	65	18	65	18
	San Francisco	85	29	65	18	65	18
Colorado	Denver	95	35	64	18	60	16
Connecticut	Hartford	93	34	75	24	65	18
	New Haven	95	35	75	24	65	18
Delaware	Wilmington	95	35	78	26	65	18
Dist. of Col.	Washington	95	35	78	26	65	18
Florida	Jacksonville	95	35	78	26	80	27
	Miami	91	33	79	26	80	27
	Tampa	95	35	78	26	80	27
Georgia	Atlanta	95	35	76	24	72	21
	Augusta	98	37	76	24	75	24
	Savannah	95	35	78	26	75	24
Hawaii	Honolulu	85	29	73	23	80	27
Idaho	Boise	95	35	65	18	60	16
Illinois	Chicago	95	35	75	24	60	16
	Peoria	96	36	76	24	60	16
Indiana	Fort Wayne	95	35	75	24	60	16
	Indianapolis	95	35	76	24	60	16
Iowa	Des Moines	95	35	78	26	60	16
	Sioux City	95	35	78	26	60	16
Kansas	Topeka	100	38	78	26	60	16
	Wichita	100	38	75	24	60	16
Kentucky	Louisville	95	35	78	26	65	18
Louisiana	New Orleans	95	35	80	27	75	24
	Shreveport	100	38	78	26	70	21
Maine	Portland	90	32	73	23	60	16
Maryland	Baltimore	95	35	78	26	65	18
	Cumberland	95	35	75	24	65	18
Mass.	Boston	92	33	75	24	65	18
	Springfield	93	34	75	24	65	18
Michigan	Detroit	95	35	75	24	60	16
	Grand Rap.	95	35	75	24	60	16
	Saginaw	95	35	75	24	60	16
Minnesota	Minneapolis	92	33	77	25	60	16
Mississippi	Vicksburg	95	35	78	26	75	24
Missouri	Kansas City	100	38	76	24	60	16
	St. Louis	95	35	78	26	60	16
Montana	Helena	95	35	67	19	55	13

Extracted by permission from Handbook of Air Conditioning, Heating and Ventilation. Second Edition, by Strock and Koral, Industrial Press.

State	City	Design Dry Bulb		Design Wet Bulb		Ground Temp.	
		°F.	°C.	°F.	°C.	°F.	°C.
Nebraska	Omaha	95	35	78	26	60	16
Nevada	Reno	95	35	65	18	65	18
New Hamp.	Concord	90	32	73	23	55	13
New Jersey	Atlantic City	95	35	78	26	65	18
	Newark	95	35	75	24	65	18
	Trenton	95	35	78	26	65	18
New Mexico	Santa Fe	90	32	65	18	65	18
New York	Albany	93	34	75	24	60	16
	Buffalo	93	34	73	23	65	18
	New York	95	35	75	24	65	18
N. Carolina	Asheville	93	34	75	24	70	21
	Charlotte	95	35	78	26	70	21
	Raleigh	95	35	78	26	70	21
North Dakota	Bismarck	95	35	73	23	50	10
Ohio	Cincinnati	95	35	78	26	65	18
	Cleveland	95	35	75	24	65	18
	Columbus	95	35	76	24	60	16
	Toledo	95	35	75	24	65	18
Oklahoma	Okla. City	101	38	77	25	65	18
	Tulsa	101	38	77	25	65	18
Oregon	Portland	90	32	68	20	70	21
Pennsylvania	Erie	93	34	75	24	65	18
	Philadelphia	95	35	78	26	70	21
	Pittsburgh	95	35	75	24	65	18
	Scranton	95	35	75	24	65	18
Rhode Island	Providence	93	34	75	24	65	18
S. Carolina	Charleston	95	35	75	26	75	24
	Greenville	95	35	76	24	75	24
South Dakota	Sioux Falls	95	35	75	24	55	13
Tennessee	Chattanooga	95	35	76	24	70	21
	Knoxville	95	35	75	24	70	21
	Memphis	95	35	78	26	70	21
	Nashville	95	35	78	26	70	21
Texas	Amarillo	100	38	72	22	70	21
	Dallas	100	38	78	26	70	21
	El Paso	100	38	69	21	70	21
	Galveston	95	35	80	27	75	24
	Houston	95	35	80	27	75	24
San Antonio	100	38	78	26	75	24	
Utah	Salt Lake City	95	35	65	18	60	16
Vermont	Burlington	90	32	73	23	60	16
Virginia	Norfolk	95	35	78	26	75	24
	Richmond	95	35	78	26	70	21
	Roanoke	95	35	76	24	70	21
Washington	Seattle	85	29	65	18	75	24
	Spokane	93	34	65	18	60	16
West Virginia	Charleston	95	35	75	24	65	18
	Wheeling	95	35	75	24	65	18
Wisconsin	Green Bay	95	35	75	24	55	13
	Milwaukee	95	35	75	24	55	13
Wyoming	Cheyenne	95	35	65	18	55	13

Refrigeration Equipment Selection

General

When the hourly BTU load has been determined, equipment can now be selected based on the information obtained in the initial job survey. Some of the factors affecting equipment selection are:

1. Equipment Balance
2. Temperature Difference (T.D.)
3. Capacity Control/Product Safety
4. Type of Operation/Air Flow

1. Equipment Balance

The condensing unit is generally selected first to have capacity greater than the calculated cooling or freezing load. The unit cooler(s) must be selected to balance the capacity of the condensing unit.

The capacity of the condensing unit should be selected at a suction temperature (after correction for suction line pressure drop) which will balance with the unit cooler(s) at a desirable T.D. between the refrigerant in the unit cooler and the air in the refrigerated storage room. The condensing unit capacity must also be selected at a condensing temperature corresponding to the condensing medium (ambient air or water) temperature available at the job location.

2. Temperature Difference

For Storage Rooms Above 32°F. (0°C.)

The nature of the product determines the desirable relative humidity for the storage room. The desirable relative humidity, in turn, dictates the approximate design T.D. between the air in storage room and the refrigerant in the unit cooler.

For the general purpose cooler involving meats, vegetables, and dairy products, it is common procedure to balance the low side to the condensing unit at a 10°F. to 12°F. T.D.. It has been learned by experience that if this is done, one may expect to maintain in a cooler 80% to 85% relative humidity, which is a good range for general storage.

Load Calculation Example 2 (page 8) involved the cooling and storage of beef. The table shows that the recommended T.D. is approximately 10°F. Since the calculated load per hour based on 16 hr. of condensing unit operation was 12696 BTU/hr., the condensing unit to be selected should have a greater capacity than 12696 BTU/hr. based on a suction temperature of +23°F. (10°F. T.D. plus 2°F. allowance for suction line pressure drop).

The unit cooler to be selected should have a minimum base capacity (BTU/° T.D.) of 12696/10° T.D. or 1270 BTU/° T.D./hr. to be sure that the unit cooler is large enough to balance properly with the condensing unit.

Low relative humidity requirements permit higher T.D. which in turn will allow selection of unit coolers with small base ratings (BTU/hr./° T.D.)

For Storage Rooms Below 32°F. (0°C.)

In low temperature rooms the amount of dehydration of unwrapped products is proportional to the T.D. Since the prevention of excess dehydration is important and since low temperature condensing unit capacities drop off sharply as the suction temperature reduced, it is considered good practice to use a maximum T.D. of 10°F.

T.D.'s can be approximated by dividing the unit cooler capacity at a 1° T.D. into the condensing unit capacity at the desired saturated suction temperature (S.S.T.) for example:

$$\frac{\text{Condensing Unit Capacity at S.S.T.}}{\text{Evaporating Capacity at 1° T.D.}} = \text{T.D.}$$

Recommended Temperature Differences (T.D.)
for Four Classes of Foods (Forced Air Unit Coolers)

Class	T.D.	Approx. RH	Description of Product Classes
1	7° - 9°F.	90%	Results in a minimum amount of moisture evaporation during storage. Includes vegetables, produce, flowers, unpackaged ice and chill rooms.
2	10° - 12°F.	80 - 85%	Includes general storage & convenience store coolers, packaged meats and vegetables, fruits and similar products. Products require slightly lower relative humidity levels than those in Class 1.
3	12° - 16°F.	65 - 80%	Includes beer, wine, pharmaceuticals, potatoes and onions, tough skin fruits such as melons & short term packaged products. These products require only moderate relative humidity.
4	17° - 22°F.	50 - 65%	Includes prep and cutting rooms, beer warehouses, candy or film storage and loading docks. These applications need only low relative humidities or are unaffected by humidity.

3. Product Safety/Capacity Control

In large boxes, it is recommended that the load be divided among multiple units. A load that requires more than a 10 HP unit should be split to provide the customer with some refrigeration level in the event of mechanical failure. In addition, as refrigeration is selected for the 1% worst occurrence of the year, multiple units provide for some capacity control. In low load situations some units can be turned off and the box maintained adequately with a fraction of the horsepower necessary for the summer operation. Multiple units on staged start up also cut the demand charges assessed by the utility company which cut your customer's electric bill.

4. Type of Operation/Air Flow

Two important considerations in the selection and location of the unit cooler are uniform air distribution and air velocities which are compatible with the particular application.

The direction of the air and air throw should be such that there is movement of air where there is a heat gain; this applies to the room walls and ceiling as well as the product. The unit cooler(s) should be arranged to direct its discharge air at any doors or openings, if it all possible. Avoid placing the unit cooler in a position close to a door where it may induce additional infiltration in to the room; this can cause fan icing and a condition known as hoar-frost. Also, avoid placing a unit in the air stream of another unit, because defrosting difficulties can result.

For general storage coolers and holding freezers, there are not criteria for air velocities within the room. The total supply of air is such that approximately 40 to 80 air changes occur each hour. This is an air conditioning term which is calculated as follows:

$$\text{Air Changes} = \frac{(\text{total cfm}) \times 60}{\text{internal room volume}}$$

* includes all unit coolers and auxiliary fans

This equation disregards the air motion which is induced by the discharge air from the unit cooler. For simplicity, the gross volume of the room is used unless the product and equipment occupy more than 10% of the volume. Specific applications such as cutting rooms and banana ripening rooms have desired limits. The table below indicates the minimum and maximum quantities of air for particular applications.

Recommended Air Changes/Hour

Type of Application	Recommended Number of Air Changes	
	Minimum	Maximum
Holding freezer	40	80
Packaged Holding center	40	80
Cutting Room	20	30
Meat Chill Room	80	120
Boxed Banana Ripening	120	200
Vegetables and Fruit Storage	30	60
Blast Freezer	150	300
Work Areas	20	30
Unpackaged Meat Storage	30	60

Derating Factors

- Ambient
- Altitude
- Saturated Suction Temperature (S.S.T.)
- 50 Cycle Power

In the selection of refrigeration equipment it should be noted that the manufacturer's equipment has ratings based on certain criteria. Care should be taken to determine actual job conditions and the proper derating factors should be applied. These factors may vary by manufacturer but can be used here as rule of thumb approximation.

A. Ambient

Condensing unit ambient is of concern as most equipment is generally cataloged as 90° to 95°F. ambient.

Decrease condensing unit capacity 6% for each 10°F. increase in operating ambient.

Increase condensing unit capacity 6% for each 10°F. decrease in operating ambient.

B. Altitude

Most manufacturers rate their equipment at sea level conditions. An increase in altitude results in a decrease in air density. While the fans on direct drive equipment will deliver a constant cubic feet per minute of air regardless of density, the thinness of the air will affect capacity performance. Belt drive equipment can be speeded up to compensate for the decrease in air density.

Effects of Altitude on Air Cooled Equipment

Altitude Feet Above Sea Level	Absolute Pressure		Standard Air Density At 70°F. lbs./Cu.Ft.	Air Dens. Ratio	Capacity Multipliers	
	In. Hg.	PSIA			Direct Drive Fans	
					Refrig. Evap.	Air Cooled Cond. Unit
-1,000	31.02	15.27	.0778	1.04	1.03	1.005
-500	30.47	14.97	.0763	1.02	1.02	1.002
0	29.92	14.70	.0749	1.00	1.00	1.00
500	29.38	14.43	.0735	0.98	0.98	0.995
1,000	28.86	14.28	.0719	0.96	0.96	0.998
2,000	27.82	13.67	.0697	0.93	0.93	0.985
3,000	26.81	13.27	.0671	0.90	0.90	0.98
4,000	25.84	12.70	.0647	0.86	0.875	0.975
5,000	24.89	12.23	.0623	0.83	0.85	0.969
6,000	23.98	11.78	.0600	0.80	0.82	0.960
7,000	23.09	11.34	.0578	0.77	0.79	0.955
8,000	22.22	10.92	.0556	0.74	0.76	0.946
9,000	21.38	10.50	.0535	0.71	0.73	0.939
10,000	20.58	10.11	.0515	0.69	0.71	0.93
12,000	19.03	9.35	.0477	0.64	0.66	0.91
14,000	17.57	8.63	.0439	0.59	0.61	0.88

C. Suction Temperature

Care should be taken in the selection of unit coolers, especially freezer models. There is no set rating standard adopted by the industry for the ratings criteria. The model number of a low temperature unit cooler can be rated at -30° SST, -20° SST, -10° SST, 0° SST, or even +10° SST. The capacity difference between the -30° SST and the +10° SST can be as much as 15% higher for the lower rated unit cooler. Most manufacturers provide a suction temperature correction factor for their unit coolers and this should be noted in equipment selections.

D. 50 Cycle Power

Since we live in a "global village," the opportunity to quote refrigeration equipment for export markets is one not to be ignored. Motors that are sized for 60 cycle operation run at 83% (50/60) speed on 50 cycles operation. Compressors produce only 5/6 of their capacity. However, while fans are only running 83% speed, there is also a decrease in static pressure through the condenser or unit cooler coil and performance does not suffer the full 17% penalty. If it has been verified by the manufacturer that their equipment can be run on 50 cycle power then the following derating factors can be applied:

- Unit coolers and air-cooled condensers (Capacity x 0.92)
- Air-cooled condensing units (capacity x .85)

System capacity (unit cooler and air-cooled condensing unit) can be derated by 0.88

To select refrigeration equipment after the load has been determined, divide the BTUH required by (0.88):

$$\frac{\text{BTUH}}{0.88} = \text{Conversion to select 60 cycle equipment for 50 cycle load}$$

This provides for larger equipment necessary to compensate for 50 cycle derating factor.

General Guidelines

Application	T.D.	Coil	Notes
Convenience Store	10 - 15°F.	Low Silhouette	Multiple units for adequate air coverage Up to 18' long = 1 coil Up to 30' long = 2 coils Up to 40' long = 3 coils Estimating guide: Cooler 100 SF/ton* Freezer 75 SF/ton*
Holding Warehouse	10 - 15°F.	Medium or Heavy Duty	Forklift Operation Average air changes Product load 10 - 15% of total load Estimating guide: 200 - 300 SF/ton
Produce Warehouse	7 - 10°F.	Low Velocity Medium or Heavy Duty	High seasonal loads Heavy product respiration Additional humidity may be required Estimating guide: 150 - 200 SF/ton
Blast Cooler or Freezer	7 - 10°F.	Heavy Duty	High air velocity, heavy infiltration Fast defrost (4-6 FPI coils) Product spaced to allow air circulation Equipment sized to extract all interior heat Box temp below desired product temperature Multiple units to provide capacity control 1.5 safety factor sometimes applied to handle initial high rate of product heat evolution
Ice Cream Hardening	10°F.	Heavy Duty	10 hour pull down with product 30% frozen and a certain percentage over run (thickness of ice cream)
Controlled Temperature Beer Warehouse	15 - 20°F.	Heavy Duty	Floating box temperature (40-72°F.) contingent on average monthly dew point Auxiliary air circulation may be required due to high T.D. Heavy loading - high infiltration 20 - 30°F. pull down on beer
Candy Warehouse	20 - 25°F.	Heavy Duty	Low relative humidity Auxiliary air circulation and reheat may be required Vapor barrier essential
Prep Room	20°F.	Low Velocity	Heavy motor and personnel load Estimating guide: 150 SF/ton
Floral Box	8°F.	Low Velocity	Light loading conditions Glass Walls Estimating guide 100 SF/ton*

SF = Floor Square Foot ton = 12,000 BTUH

Note: Estimating guide ball park figures only. All attempts should be made to obtain accurate job survey and subsequent refrigeration calculations.

* Glass doors assumed on one long wall only

Unit Cooler Recommended Coil Replacement

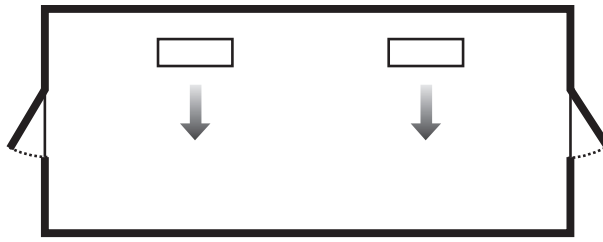
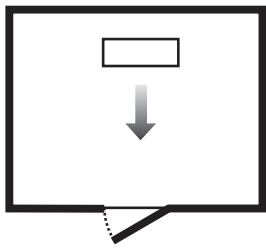

Left
Large cooler or freezer

Right
Large cooler or freezer

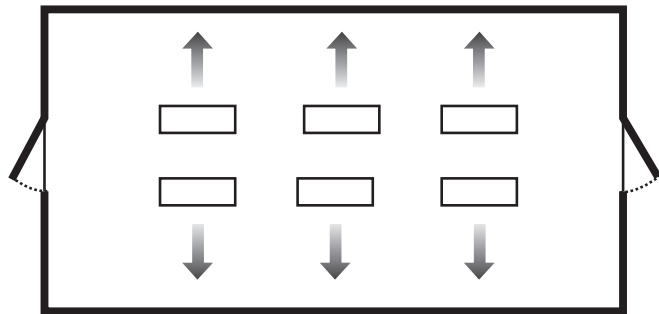

Large cooler or freezer where one wall will not accommodate all required evaporators or where air-throw distance must be considered.

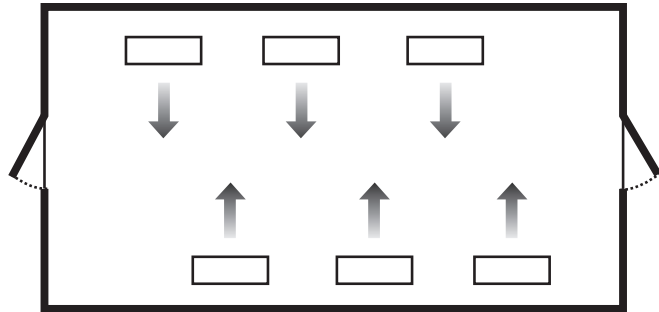

Note: Always avoid placement of unit coolers directly above doors and door openings where low and normal temperature is being maintained.

Allow sufficient space between rear of unit cooler and wall to permit free return of air. Refer to unit manufacturers' catalog for proper space.

Always trap drain lines individually to prevent vapor migration. Traps on low temperature units must be outside of refrigerated enclosures.

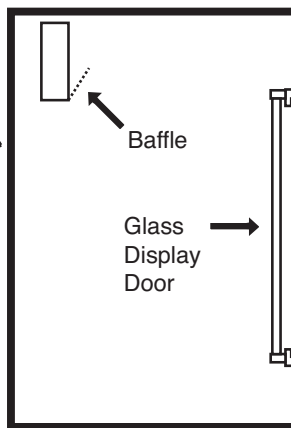
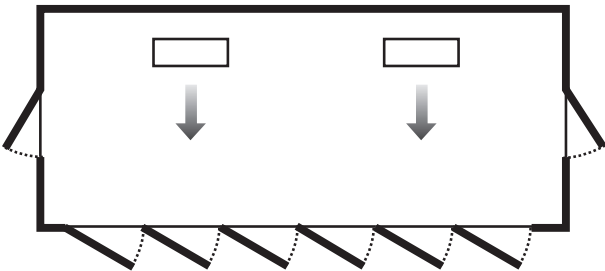

Left
Cooler or freezer with glass display doors

Right
Elevation view of glass display door cooler or freezer. Be sure Air Discharge blows above, not directly at doors. Provide baffle if door extends above blower level.

Line Sizing

The following Tables 22 through 24A on pages 25 through 30 indicate liquid lines and suction lines for all condensing units for R-22, R-404A, R-134a, and R-507.

When determining the refrigerant line length, be sure to add an allowance for fittings. See Table 26 on page 31. Total equivalent length of refrigerant lines is the sum of the actual linear footage and the allowance for fittings.

Table 22. Recommended Line Sizes for R-134a *

SYSTEM CAPACITY BTU/H	SUCTION LINE SIZE																	
	SUCTION TEMPERATURE																	
	+40°F						+30°F						+20°F					
	Equivalent Lengths						Equivalent Lengths						Equivalent Lengths					
	25'	50'	75'	100'	150'	200'	25'	50'	75'	100'	150'	200'	25'	50'	75'	100'	150'	200'
1,000	3/8	3/8	3/8	3/8	3/8	1/2	3/8	3/8	3/8	3/8	1/2	1/2	3/8	1/2	1/2	1/2	1/2	5/8
3,000	3/8	1/2	1/2	1/2	5/8	5/8	1/2	1/2	1/2	5/8	5/8	5/8	1/2	5/8	5/8	7/8	7/8	7/8
4,000	1/2	1/2	5/8	5/8	5/8	5/8	1/2	1/2	5/8	5/8	5/8	7/8	5/8	5/8	7/8	7/8	7/8	7/8
6,000	1/2	5/8	5/8	5/8	7/8	7/8	1/2	5/8	5/8	7/8	7/8	7/8	5/8	5/8	7/8	7/8	7/8	7/8
9,000	5/8	5/8	7/8	7/8	7/8	7/8	5/8	7/8	7/8	7/8	7/8	7/8	5/8	7/8	7/8	7/8	7/8	1 1/8
12,000	5/8	7/8	7/8	7/8	7/8	7/8	7/8	7/8	7/8	7/8	1 1/8	1 1/8	7/8	7/8	7/8	1 1/8	1 1/8	1 1/8
15,000	7/8	7/8	7/8	7/8	1 1/8	1 1/8	7/8	7/8	7/8	1 1/8	1 1/8	1 1/8	7/8	7/8	7/8	1 1/8	1 1/8	1 1/8
18,000	7/8	7/8	7/8	7/8	1 1/8	1 1/8	7/8	7/8	1 1/8	1 1/8	1 1/8	1 1/8	7/8	7/8	1 1/8	1 1/8	1 1/8	1 3/8
24,000	7/8	7/8	1 1/8	1 1/8	1 1/8	1 1/8	7/8	1 1/8	1 1/8	1 1/8	1 3/8	1 3/8	7/8	1 1/8	1 1/8	1 1/8	1 3/8	1 3/8
30,000	7/8	1 1/8	1 1/8	1 1/8	1 3/8	1 3/8	7/8	1 1/8	1 1/8	1 3/8	1 3/8	1 3/8	1 1/8	1 1/8	1 1/8	1 3/8	1 3/8	1 3/8
36,000	7/8	1 1/8	1 1/8	1 1/8	1 3/8	1 3/8	1 1/8	1 1/8	1 3/8	1 3/8	1 3/8	1 5/8	1 1/8	1 1/8	1 3/8	1 3/8	1 5/8	1 5/8
42,000	1 1/8	1 1/8	1 1/8	1 3/8	1 3/8	1 3/8	1 1/8	1 1/8	1 3/8	1 3/8	1 5/8	1 5/8	1 1/8	1 3/8	1 3/8	1 3/8	1 5/8	1 5/8
48,000	1 1/8	1 1/8	1 3/8	1 3/8	1 3/8	1 5/8	1 1/8	1 3/8	1 3/8	1 3/8	1 5/8	1 5/8	1 1/8	1 3/8	1 5/8	1 5/8	1 5/8	1 5/8
54,000	1 1/8	1 1/8	1 3/8	1 3/8	1 5/8	1 5/8	1 1/8	1 3/8	1 3/8	1 5/8	1 5/8	1 5/8	1 1/8	1 3/8	1 5/8	1 5/8	1 5/8	2 1/8
60,000	1 1/8	1 3/8	1 3/8	1 3/8	1 5/8	1 5/8	1 1/8	1 3/8	1 3/8	1 5/8	1 5/8	2 1/8	1 3/8	1 3/8	1 5/8	1 5/8	2 1/8	2 1/8
66,000	1 1/8	1 3/8	1 3/8	1 5/8	1 5/8	1 5/8	1 3/8	1 3/8	1 5/8	1 5/8	2 1/8	2 1/8	1 3/8	1 5/8	1 5/8	1 5/8	2 1/8	2 1/8
72,000	1 1/8	1 3/8	1 5/8	1 5/8	1 5/8	2 1/8	1 3/8	1 3/8	1 5/8	1 5/8	2 1/8	2 1/8	1 3/8	1 5/8	2 1/8	2 1/8	2 1/8	2 1/8
78,000	1 1/8	1 3/8	1 5/8	1 5/8	1 5/8	2 1/8	1 3/8	1 5/8	1 5/8	1 5/8	2 1/8	2 1/8	1 3/8	1 5/8	2 1/8	2 1/8	2 1/8	2 1/8
84,000	1 3/8	1 3/8	1 5/8	1 5/8	2 1/8	2 1/8	1 3/8	1 5/8	1 5/8	2 1/8	2 1/8	2 1/8	1 3/8	1 5/8	2 1/8	2 1/8	2 1/8	2 1/8
90,000	1 3/8	1 3/8	1 5/8	1 5/8	2 1/8	2 1/8	1 3/8	1 5/8	1 5/8	2 1/8	2 1/8	2 1/8	1 3/8	1 5/8	2 1/8	2 1/8	2 1/8	2 1/8
120,000	1 3/8	1 5/8	2 1/8	2 1/8	2 1/8	2 1/8	1 5/8	1 5/8	2 1/8	2 1/8	2 1/8	2 5/8	1 5/8	2 1/8	2 1/8	2 1/8	2 5/8	2 5/8
150,000	1 5/8	2 1/8	2 1/8	2 1/8	2 1/8	2 5/8	1 5/8	2 1/8	2 1/8	2 1/8	2 5/8	2 5/8	2 1/8	2 1/8	2 5/8	2 5/8	2 5/8	2 5/8
180,000	1 5/8	2 1/8	2 1/8	2 1/8	2 5/8	2 5/8	1 5/8	2 1/8	2 1/8	2 5/8	2 5/8	2 5/8	2 1/8	2 1/8	2 5/8	2 5/8	2 5/8	3 1/8
210,000	1 5/8	2 1/8	2 1/8	2 1/8	2 5/8	2 5/8	2 1/8	2 1/8	2 5/8	2 5/8	2 5/8	3 1/8	2 1/8	2 1/8	2 5/8	2 5/8	3 1/8	3 1/8
240,000	2 1/8	2 1/8	2 1/8	2 5/8	2 5/8	2 5/8	2 1/8	2 1/8	2 5/8	2 5/8	2 5/8	3 1/8	2 1/8	2 5/8	2 5/8	2 5/8	3 1/8	3 1/8
300,000	2 1/8	2 1/8	2 5/8	2 5/8	2 5/8	3 1/8	2 1/8	2 5/8	2 5/8	2 5/8	3 1/8	3 1/8	2 1/8	2 5/8	3 1/8	3 1/8	3 1/8	3 5/8
360,000	2 1/8	2 5/8	2 5/8	2 5/8	3 1/8	3 1/8	2 1/8	2 5/8	2 5/8	3 1/8	3 1/8	3 5/8	2 5/8	3 1/8	3 5/8	3 5/8	4 1/8	4 1/8
480,000	2 5/8	2 5/8	3 1/8	3 1/8	3 1/8	3 5/8	2 5/8	3 1/8	3 1/8	3 1/8	3 5/8	3 5/8	3 1/8	3 5/8	3 5/8	4 1/8	5 1/8	5 1/8
600,000	2 5/8	3 1/8	3 1/8	3 1/8	3 5/8	3 5/8	2 5/8	3 1/8	3 1/8	3 5/8	3 5/8	4 1/8	3 1/8	3 5/8	4 1/8	4 1/8	5 1/8	5 1/8

* NOTES:

- Sizes that are highlighted indicate maximum suction line sizes that should be used for risers. Riser size should not exceed horizontal size. Properly placed suction traps must also be used for adequate oil return. All sizes shown are for O.D. Type L copper tubing.
- Suction line sizes selected at pressure drop equivalent to 2°F. Reduce estimate of system capacity accordingly.
- Recommended liquid line size may increase with reverse cycle hot gas systems.
- Consult factory for R-134a operation at winter conditions below 0° ambient. Heated and insulated receiver required below 0° ambient. If system load drops below 40% of design, consideration to installing double suction risers should be made.

Table 22A. Recommended Line Sizes for R-134a (continued) *

SUCTION LINE SIZE												LIQUID LINE SIZE						CAPACITY BTU/H
SUCTION TEMPERATURE												Receiver to Expansion Valve SYSTEM						
+10°F Equivalent Lengths						0°F Equivalent Lengths						Equivalent Lengths						
25'	50'	75'	100'	150'	200'	25'	50'	75'	100'	150'	200'	25'	50'	75'	100'	150'	200'	
3/8	1/2	1/2	1/2	1/2	5/8	3/8	1/2	1/2	1/2	1/2	5/8	3/8	3/8	3/8	3/8	3/8	3/8	1,000
1/2	5/8	5/8	7/8	7/8	7/8	1/2	5/8	5/8	7/8	7/8	7/8	3/8	3/8	3/8	3/8	3/8	3/8	3,000
5/8	5/8	7/8	7/8	7/8	7/8	5/8	5/8	7/8	7/8	7/8	7/8	3/8	3/8	3/8	3/8	3/8	3/8	4,000
5/8	7/8	7/8	7/8	1 1/8	1 1/8	5/8	7/8	7/8	7/8	7/8	1 1/8	3/8	3/8	3/8	3/8	3/8	3/8	6,000
7/8	7/8	7/8	1 1/8	1 1/8	1 1/8	7/8	7/8	7/8	1 1/8	1 1/8	1 1/8	3/8	3/8	3/8	3/8	3/8	1/2	9,000
7/8	7/8	1 1/8	1 1/8	1 1/8	1 3/8	7/8	1 1/8	1 1/8	1 1/8	1 1/8	1 3/8	3/8	3/8	3/8	3/8	1/2	1/2	12,000
7/8	1 1/8	1 1/8	1 1/8	1 3/8	1 3/8	7/8	1 1/8	1 1/8	1 1/8	1 3/8	1 3/8	3/8	3/8	3/8	1/2	1/2	1/2	15,000
1 1/8	1 1/8	1 1/8	1 3/8	1 3/8	1 3/8	1 1/8	1 1/8	1 1/8	1 3/8	1 3/8	1 3/8	3/8	3/8	1/2	1/2	1/2	1/2	18,000
1 1/8	1 1/8	1 3/8	1 3/8	1 3/8	1 5/8	1 1/8	1 1/8	1 3/8	1 3/8	1 5/8	1 5/8	3/8	1/2	1/2	1/2	1/2	5/8	24,000
1 1/8	1 3/8	1 3/8	1 3/8	1 5/8	1 5/8	1 1/8	1 3/8	1 3/8	1 5/8	1 5/8	1 5/8	1/2	1/2	1/2	1/2	5/8	5/8	30,000
1 3/8	1 3/8	1 3/8	1 5/8	1 5/8	2 1/8	1 3/8	1 3/8	1 5/8	1 5/8	1 5/8	2 1/8	1/2	1/2	1/2	5/8	5/8	5/8	36,000
1 3/8	1 5/8	1 5/8	2 1/8	2 1/8	2 1/8	1 3/8	1 3/8	1 5/8	1 5/8	2 1/8	2 1/8	1/2	1/2	5/8	5/8	5/8	5/8	42,000
1 3/8	1 5/8	1 5/8	2 1/8	2 1/8	2 1/8	1 3/8	1 5/8	1 5/8	2 1/8	2 1/8	2 1/8	1/2	5/8	5/8	5/8	5/8	7/8	48,000
1 3/8	1 5/8	2 1/8	2 1/8	2 1/8	2 1/8	1 3/8	1 5/8	1 5/8	2 1/8	2 1/8	2 1/8	1/2	5/8	5/8	5/8	7/8	7/8	54,000
1 5/8	1 5/8	2 1/8	2 1/8	2 1/8	2 1/8	1 3/8	2 1/8	2 1/8	2 1/8	2 1/8	2 1/8	5/8	5/8	5/8	5/8	7/8	7/8	60,000
1 5/8	2 1/8	2 1/8	2 1/8	2 1/8	2 5/8	1 5/8	2 1/8	2 1/8	2 1/8	2 1/8	2 1/8	5/8	5/8	5/8	7/8	7/8	7/8	66,000
1 5/8	2 1/8	2 1/8	2 1/8	2 5/8	2 5/8	1 5/8	2 1/8	2 1/8	2 1/8	2 1/8	2 5/8	5/8	5/8	7/8	7/8	7/8	7/8	72,000
1 5/8	2 1/8	2 1/8	2 1/8	2 5/8	2 5/8	1 5/8	2 1/8	2 1/8	2 1/8	2 5/8	2 5/8	5/8	5/8	7/8	7/8	7/8	7/8	78,000
1 5/8	2 1/8	2 1/8	2 1/8	2 5/8	2 5/8	1 5/8	2 1/8	2 1/8	2 1/8	2 5/8	2 5/8	5/8	7/8	7/8	7/8	7/8	7/8	84,000
1 5/8	2 1/8	2 1/8	2 5/8	2 5/8	2 5/8	1 5/8	2 1/8	2 1/8	2 1/8	2 5/8	2 5/8	5/8	7/8	7/8	7/8	7/8	7/8	90,000
2 1/8	2 1/8	2 5/8	2 5/8	2 5/8	3 1/8	2 1/8	2 1/8	2 5/8	2 5/8	2 5/8	3 1/8	7/8	7/8	7/8	7/8	7/8	1 1/8	120,000
2 1/8	2 5/8	2 5/8	2 5/8	3 1/8	3 1/8	2 1/8	2 5/8	2 5/8	2 5/8	3 1/8	3 1/8	7/8	7/8	7/8	7/8	1 1/8	1 1/8	150,000
2 1/8	2 5/8	2 5/8	3 1/8	3 1/8	3 1/8	2 1/8	2 5/8	2 5/8	3 1/8	3 1/8	3 1/8	7/8	7/8	7/8	1 1/8	1 1/8	1 1/8	180,000
2 5/8	2 5/8	3 1/8	3 1/8	3 5/8	3 5/8	2 5/8	2 5/8	2 5/8	3 1/8	3 1/8	3 5/8	7/8	7/8	1 1/8	1 1/8	1 1/8	1 1/8	210,000
2 5/8	2 5/8	3 1/8	3 1/8	3 5/8	3 5/8	2 5/8	2 5/8	3 1/8	3 1/8	3 5/8	3 5/8	7/8	1 1/8	1 1/8	1 1/8	1 1/8	1 3/8	240,000
2 5/8	3 1/8	3 1/8	3 5/8	3 5/8	4 1/8	2 5/8	3 1/8	3 1/8	3 5/8	3 5/8	4 1/8	1 1/8	1 1/8	1 1/8	1 1/8	1 3/8	1 3/8	300,000
2 5/8	3 1/8	3 5/8	3 5/8	4 1/8	4 1/8	2 5/8	3 1/8	3 5/8	3 5/8	4 1/8	4 1/8	1 1/8	1 1/8	1 1/8	1 3/8	1 3/8	1 5/8	360,000
3 1/8	3 5/8	3 5/8	4 1/8	5 1/8	5 1/8	3 1/8	3 5/8	3 5/8	4 1/8	5 1/8	5 1/8	1 1/8	1 1/8	1 3/8	1 3/8	1 5/8	1 5/8	480,000
3 1/8	3 5/8	4 1/8	5 1/8	5 1/8	5 1/8	3 1/8	3 5/8	4 1/8	4 1/8	5 1/8	5 1/8	1 3/8	1 3/8	1 3/8	1 5/8	1 5/8	1 5/8	600,000

* NOTES:

- Sizes that are highlighted indicate maximum suction line sizes that should be used for risers. Riser size should not exceed horizontal size. Properly placed suction traps must also be used for adequate oil return. All sizes shown are for O.D. Type L copper tubing.
- Suction line sizes selected at pressure drop equivalent to 2°F. Reduce estimate of system capacity accordingly.
- Recommended liquid line size may increase with reverse cycle hot gas systems.
- Consult factory for R-134a operation at winter conditions below 0° ambient. Heated and insulated receiver required below 0° ambient. If system load drops below 40% of design, consideration to installing double suction risers should be made.

Table 23. Recommended Line Sizes for R-22 *

SYSTEM CAPACITY BTU/H	SUCTION LINE SIZE																					
	SUCTION TEMPERATURE																					
	+40°F						+20°F						+10°F						0°F			
	Equivalent Lengths						Equivalent Lengths						Equivalent Lengths						Equivalent			
	25'	50'	75'	100'	150'	200'	25'	50'	75'	100'	150'	200'	25'	50'	75'	100'	150'	200'	25'	50'	75'	
1,000	3/8	3/8	3/8	3/8	3/8	3/8	3/8	3/8	3/8	3/8	3/8	3/8	3/8	3/8	3/8	3/8	3/8	3/8	1/2	3/8	3/8	3/8
3,000	3/8	3/8	3/8	1/2	1/2	1/2	3/8	1/2	1/2	1/2	5/8	5/8	3/8	1/2	1/2	1/2	5/8	5/8	5/8	1/2	1/2	1/2
4,000	3/8	3/8	1/2	1/2	1/2	1/2	3/8	1/2	1/2	1/2	5/8	5/8	1/2	1/2	1/2	5/8	5/8	5/8	1/2	1/2	5/8	
6,000	1/2	1/2	1/2	5/8	5/8	5/8	1/2	1/2	5/8	5/8	5/8	5/8	1/2	5/8	5/8	5/8	7/8	7/8	5/8	5/8	5/8	
9,000	1/2	5/8	5/8	5/8	7/8	7/8	1/2	5/8	5/8	5/8	7/8	7/8	5/8	5/8	7/8	7/8	7/8	7/8	5/8	7/8	7/8	
12,000	5/8	5/8	5/8	7/8	7/8	7/8	5/8	5/8	7/8	7/8	7/8	7/8	5/8	7/8	7/8	7/8	7/8	7/8	5/8	7/8	7/8	
15,000	5/8	5/8	7/8	7/8	7/8	7/8	5/8	7/8	7/8	7/8	7/8	7/8	7/8	7/8	7/8	7/8	11/8	11/8	7/8	7/8	7/8	
18,000	5/8	7/8	7/8	7/8	7/8	1 1/8	5/8	7/8	7/8	7/8	7/8	1 1/8	7/8	7/8	7/8	7/8	11/8	11/8	7/8	7/8	1 1/8	
24,000	5/8	7/8	7/8	7/8	1 1/8	1 1/8	7/8	7/8	7/8	7/8	1 1/8	1 1/8	7/8	7/8	1 1/8	1 1/8	1 1/8	1 1/8	7/8	1 1/8	1 1/8	
30,000	7/8	7/8	7/8	1 1/8	1 1/8	1 1/8	7/8	7/8	7/8	1 1/8	1 1/8	1 1/8	7/8	1 1/8	1 1/8	1 1/8	1 1/8	1 1/8	1 1/8	1 1/8	1 1/8	
36,000	7/8	1 1/8	1 1/8	1 1/8	1 1/8	1 3/8	7/8	1 1/8	1 1/8	1 1/8	1 1/8	1 3/8	7/8	1 1/8	1 1/8	1 1/8	1 3/8	1 3/8	1 1/8	1 1/8	1 1/8	
42,000	7/8	1 1/8	1 1/8	1 1/8	1 1/8	1 3/8	7/8	1 1/8	1 1/8	1 1/8	1 3/8	1 3/8	1 1/8	1 1/8	1 1/8	1 3/8	1 3/8	1 3/8	1 1/8	1 1/8	1 3/8	
48,000	7/8	1 1/8	1 1/8	1 1/8	1 1/8	1 3/8	7/8	1 1/8	1 1/8	1 1/8	1 3/8	1 3/8	1 1/8	1 1/8	1 3/8	1 3/8	1 3/8	1 3/8	1 1/8	1 3/8	1 3/8	
54,000	7/8	1 1/8	1 1/8	1 1/8	1 3/8	1 3/8	1 1/8	1 1/8	1 1/8	1 3/8	1 3/8	1 3/8	1 1/8	1 3/8	1 3/8	1 3/8	1 5/8	1 5/8	1 1/8	1 3/8	1 3/8	
60,000	7/8	1 1/8	1 1/8	1 1/8	1 3/8	1 3/8	1 1/8	1 1/8	1 1/8	1 3/8	1 3/8	1 5/8	1 1/8	1 3/8	1 3/8	1 3/8	1 5/8	1 5/8	1 1/8	1 3/8	1 3/8	
66,000	7/8	1 1/8	1 1/8	1 3/8	1 3/8	1 3/8	1 1/8	1 1/8	1 3/8	1 3/8	1 3/8	1 5/8	1 1/8	1 3/8	1 3/8	1 3/8	1 5/8	1 5/8	1 1/8	1 3/8	1 5/8	
72,000	1 1/8	1 1/8	1 1/8	1 3/8	1 3/8	1 3/8	1 1/8	1 3/8	1 3/8	1 3/8	1 5/8	1 5/8	1 1/8	1 3/8	1 3/8	1 5/8	1 5/8	1 5/8	1 3/8	1 3/8	1 5/8	
78,000	1 1/8	1 1/8	1 3/8	1 3/8	1 3/8	1 5/8	1 1/8	1 3/8	1 3/8	1 3/8	1 5/8	1 5/8	1 1/8	1 3/8	1 5/8	1 5/8	1 5/8	2 1/8	1 3/8	1 3/8	1 5/8	
84,000	1 1/8	1 1/8	1 3/8	1 3/8	1 3/8	1 5/8	1 1/8	1 3/8	1 3/8	1 3/8	1 5/8	1 5/8	1 3/8	1 3/8	1 5/8	1 5/8	1 5/8	2 1/8	1 3/8	1 5/8	1 5/8	
90,000	1 1/8	1 3/8	1 3/8	1 3/8	1 5/8	1 5/8	1 1/8	1 3/8	1 3/8	1 5/8	1 5/8	2 1/8	1 3/8	1 3/8	1 5/8	1 5/8	2 1/8	2 1/8	1 3/8	1 5/8	1 5/8	
120,000	1 1/8	1 3/8	1 3/8	1 5/8	1 5/8	2 1/8	1 3/8	1 3/8	1 5/8	1 5/8	2 1/8	2 1/8	1 3/8	1 5/8	1 5/8	2 1/8	2 1/8	2 1/8	1 5/8	5/8	2 1/8	
150,000	1 3/8	1 3/8	1 5/8	1 5/8	2 1/8	2 1/8	1 3/8	1 5/8	1 5/8	2 1/8	2 1/8	2 1/8	1 5/8	1 5/8	1 5/8	2 1/8	2 1/8	2 5/8	1 5/8	2 1/8	2 1/8	
180,000	1 3/8	1 5/8	1 5/8	2 1/8	2 1/8	2 1/8	1 3/8	1 5/8	2 1/8	2 1/8	2 1/8	2 1/8	1 5/8	2 1/8	2 1/8	2 1/8	2 5/8	2 5/8	1 5/8	2 1/8	2 1/8	
210,000	1 3/8	1 5/8	1 5/8	2 1/8	2 1/8	2 1/8	1 5/8	2 1/8	2 1/8	2 1/8	2 1/8	2 5/8	1 5/8	2 1/8	2 1/8	2 1/8	2 5/8	2 5/8	2 1/8	2 1/8	2 1/8	
240,000	1 5/8	1 5/8	2 1/8	2 1/8	2 1/8	2 5/8	1 5/8	2 1/8	2 1/8	2 1/8	2 5/8	2 5/8	2 1/8	2 1/8	2 1/8	2 5/8	2 5/8	2 5/8	2 1/8	2 1/8	2 5/8	
300,000	1 5/8	2 1/8	2 1/8	2 1/8	2 5/8	2 5/8	2 1/8	2 1/8	2 1/8	2 5/8	2 5/8	2 5/8	2 1/8	2 1/8	2 5/8	2 5/8	2 5/8	3 1/8	2 1/8	2 5/8	2 5/8	
360,000	2 1/8	2 1/8	2 1/8	2 5/8	2 5/8	2 5/8	2 1/8	2 1/8	2 5/8	2 5/8	2 5/8	3 1/8	2 1/8	2 5/8	2 5/8	2 5/8	3 1/8	3 1/8	2 1/8	2 5/8	2 5/8	
480,000	2 1/8	2 1/8	2 5/8	2 5/8	2 5/8	3 1/8	2 1/8	2 5/8	2 5/8	2 5/8	3 1/8	3 1/8	2 1/8	2 5/8	2 5/8	3 1/8	3 1/8	3 5/8	2 5/8	2 5/8	3 1/8	
600,000	2 1/8	2 5/8	2 5/8	2 5/8	3 1/8	3 1/8	2 1/8	2 5/8	3 1/8	3 1/8	3 1/8	3 5/8	2 5/8	2 5/8	3 1/8	3 1/8	3 5/8	3 5/8	2 5/8	3 1/8	3 1/8	

* NOTES:

- Sizes that are highlighted indicate maximum suction line sizes that should be used for risers. Riser size should not exceed horizontal size. Properly placed suction traps must also be used for adequate oil return.
All sizes shown are for O.D. Type L copper tubing.
- Suction line sizes selected at pressure drop equivalent to 2°F. Reduce estimate of system capacity accordingly.
- Recommended liquid line size may increase with reverse cycle hot gas systems.
- If system load drops below 40% of design, consideration to installing double suction risers should be made.

Table 23A. Recommended Line Sizes for R-22 (continued) *

SUCTION LINE SIZE															LIQUID LINE SIZE						SYSTEM CAPACITY BTU/H					
SUCTION TEMPERATURE															Receiver to Expansion Valve											
0°F			-10°F						-20°F						Equivalent Lengths											
Lengths			Equivalent Lengths						Equivalent Lengths						Equivalent Lengths											
100'	150'	200'	25'	50'	75'	100'	150'	200'	25'	50'	75'	100'	150'	200'	25'	50'	75'	100'	150'	200'	25'	50'	75'	100'	150'	200'
3/8	1/2	1/2	3/8	3/8	3/8	3/8	1/2	1/2	3/8	3/8	3/8	1/2	1/2	1/2	3/8	3/8	3/8	3/8	3/8	3/8	3/8	3/8	3/8	3/8	1,000	
5/8	5/8	5/8	1/2	1/2	1/2	5/8	5/8	5/8	1/2	1/2	5/8	5/8	5/8	7/8	3/8	3/8	3/8	3/8	3/8	3/8	3/8	3/8	3/8	3/8	3,000	
5/8	5/8	7/8	1/2	1/2	5/8	5/8	5/8	7/8	1/2	5/8	5/8	5/8	7/8	7/8	3/8	3/8	3/8	3/8	3/8	3/8	3/8	3/8	3/8	3/8	4,000	
5/8	7/8	7/8	1/2	5/8	5/8	7/8	7/8	7/8	5/8	5/8	7/8	7/8	7/8	7/8	3/8	3/8	3/8	3/8	3/8	3/8	3/8	3/8	3/8	3/8	6,000	
7/8	7/8	7/8	5/8	7/8	7/8	7/8	7/8	7/8	5/8	7/8	7/8	7/8	1 1/8	1 1/8	3/8	3/8	3/8	3/8	3/8	3/8	3/8	3/8	3/8	3/8	9,000	
7/8	7/8	1 1/8	7/8	7/8	7/8	7/8	1 1/8	1 1/8	7/8	7/8	7/8	1 1/8	1 1/8	1 1/8	3/8	3/8	3/8	3/8	3/8	3/8	3/8	3/8	3/8	3/8	12,000	
7/8	1 1/8	1 1/8	7/8	7/8	7/8	1 1/8	1 1/8	1 1/8	7/8	7/8	1 1/8	1 1/8	1 1/8	1 1/8	3/8	3/8	3/8	3/8	3/8	3/8	3/8	1/2	1/2	1/2	15,000	
1 1/8	1 1/8	1 1/8	7/8	7/8	1 1/8	1 1/8	1 1/8	1 1/8	7/8	1 1/8	1 1/8	1 1/8	1 1/8	1 3/8	3/8	3/8	3/8	3/8	3/8	3/8	1/2	1/2	1/2	1/2	18,000	
1 1/8	1 1/8	1 3/8	7/8	1 1/8	1 1/8	1 1/8	1 3/8	1 3/8	7/8	1 1/8	1 1/8	1 3/8	1 3/8	1 3/8	3/8	3/8	1/2	1/2	1/2	1/2	1/2	1/2	1/2	1/2	24,000	
1 1/8	1 3/8	1 3/8	7/8	1 1/8	1 1/8	1 3/8	1 3/8	1 3/8	1 1/8	1 1/8	1 3/8	1 3/8	1 3/8	1 5/8	3/8	3/8	1/2	1/2	1/2	1/2	1/2	1/2	1/2	1/2	30,000	
1 3/8	1 3/8	1 3/8	1 1/8	1 1/8	1 3/8	1 3/8	1 3/8	1 5/8	1 1/8	1 3/8	1 3/8	1 3/8	1 5/8	1 5/8	3/8	1/2	1/2	1/2	1/2	1/2	1/2	1/2	1/2	1/2	36,000	
1 3/8	1 3/8	1 5/8	1 1/8	1 1/8	1 3/8	1 3/8	1 5/8	1 5/8	1 1/8	1 3/8	1 3/8	1 5/8	1 5/8	1 5/8	3/8	1/2	1/2	1/2	1/2	1/2	1/2	1/2	5/8	5/8	42,000	
1 3/8	1 5/8	1 5/8	1 1/8	1 3/8	1 3/8	1 3/8	1 5/8	1 5/8	1 1/8	1 3/8	1 3/8	1 5/8	1 5/8	2 1/8	1/2	1/2	1/2	1/2	1/2	1/2	1/2	5/8	5/8	5/8	48,000	
1 3/8	1 5/8	1 5/8	1 1/8	1 3/8	1 3/8	1 5/8	1 5/8	1 5/8	1 3/8	1 3/8	1 5/8	1 5/8	2 1/8	2 1/8	1/2	1/2	1/2	1/2	1/2	5/8	5/8	5/8	5/8	5/8	54,000	
1 5/8	1 5/8	2 1/8	1 1/8	1 3/8	1 3/8	1 5/8	1 5/8	2 1/8	1 3/8	1 3/8	1 5/8	1 5/8	2 1/8	2 1/8	1/2	1/2	1/2	1/2	1/2	5/8	5/8	5/8	5/8	5/8	60,000	
1 5/8	1 5/8	2 1/8	1 3/8	1 3/8	1 5/8	1 5/8	1 5/8	2 1/8	1 3/8	1 5/8	1 5/8	1 5/8	2 1/8	2 1/8	1/2	1/2	5/8	5/8	5/8	5/8	5/8	5/8	5/8	5/8	66,000	
1 5/8	2 1/8	2 1/8	1 3/8	1 3/8	1 5/8	1 5/8	2 1/8	2 1/8	1 3/8	1 5/8	1 5/8	2 1/8	2 1/8	2 1/8	1/2	1/2	5/8	5/8	5/8	5/8	5/8	5/8	5/8	5/8	72,000	
1 5/8	2 1/8	2 1/8	1 3/8	1 5/8	1 5/8	1 5/8	2 1/8	2 1/8	1 3/8	1 5/8	1 5/8	2 1/8	2 1/8	2 1/8	1/2	1/2	5/8	5/8	5/8	5/8	5/8	5/8	7/8	7/8	78,000	
1 5/8	2 1/8	2 1/8	1 3/8	1 5/8	1 5/8	2 1/8	2 1/8	2 1/8	1 3/8	1 5/8	2 1/8	2 1/8	2 1/8	2 1/8	1/2	5/8	5/8	5/8	5/8	5/8	5/8	7/8	7/8	7/8	84,000	
2 1/8	2 1/8	2 1/8	1 3/8	1 5/8	1 5/8	2 1/8	2 1/8	2 1/8	1 3/8	1 5/8	2 1/8	2 1/8	2 1/8	2 1/8	1/2	5/8	5/8	5/8	5/8	7/8	7/8	7/8	7/8	7/8	90,000	
2 1/8	2 1/8	2 1/8	1 5/8	1 5/8	2 1/8	2 1/8	2 1/8	2 5/8	1 5/8	2 1/8	2 1/8	2 1/8	2 5/8	2 5/8	5/8	5/8	5/8	7/8	7/8	7/8	7/8	7/8	7/8	7/8	120,000	
2 1/8	2 5/8	2 5/8	1 5/8	2 1/8	2 1/8	2 1/8	2 5/8	2 5/8	2 1/8	2 1/8	2 1/8	2 5/8	2 5/8	2 5/8	5/8	7/8	7/8	7/8	7/8	7/8	7/8	7/8	7/8	7/8	150,000	
2 1/8	2 5/8	2 5/8	1 5/8	2 1/8	2 1/8	2 5/8	2 5/8	2 5/8	2 1/8	2 1/8	2 5/8	2 5/8	2 5/8	3 1/8	5/8	7/8	7/8	7/8	7/8	7/8	7/8	7/8	1 1/8	1 1/8	180,000	
2 5/8	2 5/8	2 5/8	2 1/8	2 1/8	2 5/8	2 5/8	2 5/8	2 5/8	2 1/8	2 5/8	2 5/8	2 5/8	2 5/8	3 1/8	7/8	7/8	7/8	7/8	7/8	7/8	7/8	7/8	1 1/8	1 1/8	210,000	
2 5/8	2 5/8	3 1/8	2 1/8	2 1/8	2 5/8	2 5/8	2 5/8	3 1/8	2 1/8	2 5/8	2 5/8	2 5/8	3 1/8	3 1/8	7/8	7/8	7/8	7/8	7/8	1 1/8	1 1/8	1 1/8	1 1/8	1 1/8	240,000	
2 5/8	3 1/8	3 1/8	2 1/8	2 5/8	2 5/8	2 5/8	3 1/8	3 1/8	2 1/8	2 5/8	3 1/8	3 1/8	3 1/8	3 5/8	7/8	7/8	1 1/8	1 1/8	1 1/8	1 1/8	1 1/8	1 1/8	1 1/8	1 1/8	300,000	
3 1/8	3 1/8	3 1/8	2 1/8	2 5/8	2 5/8	3 1/8	3 1/8	3 5/8	2 5/8	2 5/8	3 1/8	3 1/8	3 5/8	3 5/8	7/8	7/8	1 1/8	1 1/8	1 1/8	1 1/8	1 1/8	1 1/8	1 1/8	1 1/8	360,000	
3 1/8	3 5/8	3 5/8	2 5/8	3 1/8	3 1/8	3 1/8	3 5/8	3 5/8	2 5/8	3 1/8	3 5/8	3 5/8	3 5/8	4 1/8	1 1/8	1 1/8	1 1/8	1 1/8	1 1/8	1 1/8	1 1/8	1 3/8	1 3/8	1 3/8	480,000	
3 5/8	3 5/8	4 1/8	2 5/8	3 1/8	3 1/8	3 5/8	3 5/8	4 1/8	3 1/8	3 1/8	3 5/8	3 5/8	4 1/8	4 1/8	1 1/8	1 1/8	1 1/8	1 3/8	1 3/8	1 3/8	1 3/8	1 3/8	1 3/8	1 3/8	600,000	

* NOTES:

- Sizes that are highlighted indicate maximum suction line sizes that should be used for risers. Riser size should not exceed horizontal size. Properly placed suction traps must also be used for adequate oil return. All sizes shown are for O.D. Type L copper tubing.
- Suction line sizes selected at pressure drop equivalent to 2°F. Reduce estimate of system capacity accordingly.
- Recommended liquid line size may increase with reverse cycle hot gas systems.
- If system load drops below 40% of design, consideration to installing double suction risers should be made.

Table 24. Recommended Line Sizes for R-404A and R-507 *

SYSTEM CAPACITY BTU/H	SUCTION LINE SIZE																				
	SUCTION TEMPERATURE																				
	+20°F						+10°F						-10°F						-20°F		
	Equivalent Lengths						Equivalent Lengths						Equivalent Lengths						Equivalent		
	25'	50'	75'	100'	150'	200'	25'	50'	75'	100'	150'	200'	25'	50'	75'	100'	150'	200'	25'	50'	75'
1,000	3/8	3/8	3/8	3/8	3/8	3/8	3/8	3/8	3/8	3/8	3/8	1/2	3/8	3/8	3/8	1/2	1/2	1/2	3/8	3/8	1/2
3,000	3/8	3/8	1/2	1/2	1/2	5/8	3/8	1/2	1/2	1/2	5/8	5/8	1/2	1/2	5/8	5/8	5/8	7/8	1/2	1/2	5/8
4,000	3/8	1/2	1/2	1/2	5/8	5/8	1/2	1/2	1/2	5/8	5/8	7/8	1/2	5/8	5/8	5/8	7/8	7/8	1/2	5/8	5/8
6,000	1/2	1/2	5/8	5/8	7/8	7/8	1/2	1/2	5/8	5/8	7/8	7/8	1/2	5/8	5/8	7/8	7/8	7/8	5/8	5/8	7/8
9,000	5/8	5/8	7/8	7/8	7/8	7/8	5/8	5/8	7/8	7/8	7/8	7/8	5/8	7/8	7/8	7/8	7/8	1 1/8	5/8	7/8	7/8
12,000	5/8	7/8	7/8	7/8	7/8	7/8	5/8	7/8	7/8	7/8	7/8	1 1/8	7/8	7/8	7/8	7/8	1 1/8	1 1/8	7/8	7/8	7/8
15,000	5/8	7/8	7/8	7/8	7/8	1 1/8	7/8	7/8	7/8	7/8	1 1/8	1 1/8	7/8	7/8	7/8	1 1/8	1 1/8	1 1/8	7/8	7/8	1 1/8
18,000	7/8	7/8	7/8	7/8	1 1/8	1 1/8	7/8	7/8	7/8	1 1/8	1 1/8	1 1/8	7/8	7/8	1 1/8	1 1/8	1 1/8	1 3/8	7/8	1 1/8	1 1/8
24,000	7/8	7/8	7/8	1 1/8	1 1/8	1 1/8	7/8	1 1/8	1 1/8	1 1/8	1 1/8	1 3/8	7/8	1 1/8	1 1/8	1 1/8	1 3/8	1 3/8	1 1/8	1 1/8	1 1/8
30,000	7/8	7/8	1 1/8	1 1/8	1 1/8	1 3/8	7/8	1 1/8	1 1/8	1 1/8	1 3/8	1 3/8	1 1/8	1 1/8	1 1/8	1 3/8	1 3/8	1 3/8	1 1/8	1 1/8	1 1/8
36,000	7/8	1 1/8	1 1/8	1 1/8	1 3/8	1 3/8	1 1/8	1 1/8	1 1/8	1 3/8	1 3/8	1 3/8	1 1/8	1 1/8	1 3/8	1 3/8	1 3/8	1 5/8	1 1/8	1 1/8	1 3/8
42,000	1 1/8	1 1/8	1 1/8	1 3/8	1 3/8	1 3/8	1 1/8	1 1/8	1 3/8	1 3/8	1 3/8	1 5/8	1 1/8	1 3/8	1 3/8	1 3/8	1 5/8	1 5/8	1 1/8	1 3/8	1 3/8
48,000	1 1/8	1 1/8	1 3/8	1 3/8	1 3/8	1 3/8	1 1/8	1 1/8	1 3/8	1 3/8	1 5/8	1 5/8	1 1/8	1 3/8	1 3/8	1 3/8	1 5/8	1 5/8	1 1/8	1 3/8	1 3/8
54,000	1 1/8	1 1/8	1 3/8	1 3/8	1 3/8	1 5/8	1 1/8	1 3/8	1 3/8	1 3/8	1 5/8	1 5/8	1 3/8	1 3/8	1 3/8	1 5/8	1 5/8	1 5/8	1 3/8	1 3/8	1 5/8
60,000	1 1/8	1 1/8	1 3/8	1 3/8	1 5/8	1 5/8	1 1/8	1 3/8	1 3/8	1 5/8	1 5/8	1 5/8	1 3/8	1 3/8	1 5/8	1 5/8	1 5/8	2 1/8	1 3/8	1 3/8	1 5/8
66,000	1 1/8	1 3/8	1 3/8	1 3/8	1 5/8	1 5/8	1 1/8	1 3/8	1 3/8	1 5/8	1 5/8	1 5/8	1 3/8	1 5/8	1 5/8	1 5/8	1 5/8	1 5/8	1 3/8	1 5/8	1 5/8
72,000	1 1/8	1 3/8	1 3/8	1 5/8	1 5/8	1 5/8	1 1/8	1 3/8	1 5/8	1 5/8	1 5/8	1 5/8	1 3/8	1 5/8	1 5/8	1 5/8	1 5/8	1 5/8	1 3/8	1 5/8	1 5/8
78,000	1 1/8	1 3/8	1 3/8	1 5/8	1 5/8	2 1/8	1 3/8	1 3/8	1 5/8	1 5/8	1 5/8	2 1/8	1 3/8	1 5/8	1 5/8	1 5/8	1 5/8	2 1/8	1 5/8	1 5/8	1 5/8
84,000	1 1/8	1 3/8	1 5/8	1 5/8	1 5/8	2 1/8	1 3/8	1 3/8	1 5/8	1 5/8	2 1/8	2 1/8	1 3/8	1 5/8	1 5/8	1 5/8	2 1/8	2 1/8	1 5/8	1 5/8	1 5/8
90,000	1 3/8	1 3/8	1 5/8	1 5/8	2 1/8	2 1/8	1 3/8	1 5/8	1 5/8	1 5/8	2 1/8	2 1/8	1 5/8	1 5/8	1 5/8	2 1/8	2 1/8	2 5/8	1 5/8	1 5/8	2 1/8
120,000	1 3/8	1 5/8	1 5/8	2 1/8	2 1/8	2 1/8	1 3/8	1 5/8	2 1/8	2 1/8	2 1/8	2 1/8	1 5/8	2 1/8	2 1/8	2 1/8	2 5/8	2 5/8	1 5/8	2 1/8	2 1/8
150,000	1 5/8	1 5/8	2 1/8	2 1/8	2 1/8	2 1/8	1 5/8	2 1/8	2 1/8	2 1/8	2 1/8	2 5/8	2 1/8	2 1/8	2 1/8	2 5/8	2 5/8	2 5/8	2 1/8	2 1/8	2 1/8
180,000	1 5/8	2 1/8	2 1/8	2 1/8	2 1/8	2 5/8	1 5/8	2 1/8	2 1/8	2 1/8	2 5/8	2 5/8	2 1/8	2 1/8	2 5/8	2 5/8	2 5/8	3 1/8	2 1/8	2 1/8	2 5/8
210,000	1 5/8	2 1/8	2 1/8	2 1/8	2 5/8	2 5/8	2 1/8	2 1/8	2 1/8	2 5/8	2 5/8	2 5/8	2 1/8	2 1/8	2 5/8	2 5/8	3 1/8	3 1/8	2 1/8	2 5/8	2 5/8
240,000	1 5/8	2 1/8	2 1/8	2 1/8	2 5/8	2 5/8	2 1/8	2 1/8	2 5/8	2 5/8	2 5/8	2 5/8	2 1/8	2 5/8	2 5/8	2 5/8	3 1/8	3 1/8	2 1/8	2 5/8	2 5/8
300,000	2 1/8	2 1/8	2 5/8	2 5/8	2 5/8	3 1/8	2 1/8	2 5/8	2 5/8	2 5/8	3 1/8	3 1/8	2 5/8	2 5/8	2 5/8	3 1/8	3 1/8	3 5/8	2 5/8	2 5/8	2 5/8
360,000	2 1/8	2 1/8	2 5/8	2 5/8	3 1/8	3 1/8	2 1/8	2 5/8	2 5/8	2 5/8	3 1/8	3 1/8	2 5/8	2 5/8	3 1/8	3 1/8	3 5/8	3 5/8	2 5/8	2 5/8	3 1/8
480,000	2 1/8	2 5/8	2 5/8	3 1/8	3 1/8	3 5/8	2 5/8	2 5/8	2 5/8	2 5/8	3 5/8	3 5/8	2 5/8	3 1/8	3 1/8	3 5/8	3 5/8	4 1/8	2 5/8	3 1/8	3 1/8
600,000	2 5/8	2 5/8	3 1/8	3 1/8	3 5/8	3 5/8	2 5/8	2 5/8	3 1/8	3 1/8	3 5/8	3 5/8	3 1/8	3 1/8	3 1/8	3 5/8	4 1/8	4 1/8	3 1/8	3 1/8	3 1/8

* NOTES:

- Sizes that are highlighted indicate maximum suction line sizes that should be used for risers. Riser size should not exceed horizontal size. Properly placed suction traps must also be used for adequate oil return.
All sizes shown are for O.D. Type L copper tubing.
- Suction line sizes selected at pressure drop equivalent to 2°F. Reduce estimate of system capacity accordingly.
- Recommended liquid line size may increase with reverse cycle hot gas systems.
- If system load drops below 40% of design, consideration to installing double suction risers should be made.

Table 24A. Recommended Line Sizes for R-404A and R-507 (continued) *

SUCTION LINE SIZE															LIQUID LINE SIZE						SYSTEM CAPACITY BTU/H					
SUCTION TEMPERATURE															Receiver to											
-20°F			-30°F						-40°F						Expansion Valve			CAPACITY								
Lengths			Equivalent Lengths						Equivalent Lengths						Equivalent Lengths											
100'	150'	200'	25'	50'	75'	100'	150'	200'	25'	50'	75'	100'	150'	200'	25'	50'	75'	100'	150'	200'	25'	50'	75'	100'	150'	200'
1/2	1/2	1/2	3/8	3/8	1/2	1/2	1/2	5/8	3/8	1/2	1/2	1/2	5/8	5/8	3/8	3/8	3/8	3/8	3/8	3/8	3/8	3/8	3/8	3/8	3/8	1,000
5/8	7/8	7/8	1/2	1/2	5/8	5/8	7/8	7/8	1/2	1/2	5/8	5/8	7/8	7/8	3/8	3/8	3/8	3/8	3/8	3/8	3/8	3/8	3/8	3/8	3/8	3,000
7/8	7/8	7/8	5/8	5/8	5/8	7/8	7/8	7/8	1/2	5/8	5/8	7/8	7/8	7/8	3/8	3/8	3/8	3/8	3/8	3/8	3/8	3/8	3/8	3/8	3/8	4,000
7/8	7/8	7/8	5/8	5/8	7/8	7/8	7/8	7/8	5/8	5/8	7/8	7/8	7/8	1 1/8	3/8	3/8	3/8	3/8	3/8	3/8	3/8	3/8	3/8	3/8	3/8	6,000
7/8	1 1/8	1 1/8	5/8	7/8	7/8	7/8	1 1/8	1 1/8	5/8	7/8	7/8	7/8	1 1/8	1 1/8	3/8	3/8	3/8	3/8	3/8	3/8	3/8	3/8	3/8	3/8	3/8	9,000
1 1/8	1 1/8	1 1/8	7/8	7/8	7/8	1 1/8	1 1/8	1 1/8	7/8	7/8	7/8	1 1/8	1 1/8	1 1/8	3/8	3/8	3/8	3/8	3/8	3/8	3/8	3/8	3/8	1/2	1/2	12,000
1 1/8	1 1/8	1 3/8	7/8	7/8	1 1/8	1 1/8	1 1/8	1 3/8	7/8	7/8	1 1/8	1 1/8	1 1/8	1 3/8	3/8	3/8	3/8	3/8	3/8	1/2	1/2	1/2	1/2	1/2	1/2	15,000
1 1/8	1 3/8	1 3/8	7/8	1 1/8	1 1/8	1 1/8	1 3/8	1 3/8	7/8	1 1/8	1 1/8	1 1/8	1 3/8	1 3/8	3/8	3/8	3/8	1/2	1/2	1/2	1/2	1/2	1/2	1/2	1/2	18,000
1 3/8	1 3/8	1 3/8	1 1/8	1 1/8	1 1/8	1 3/8	1 3/8	1 3/8	1 1/8	1 1/8	1 1/8	1 3/8	1 3/8	1 3/8	3/8	3/8	1/2	1/2	1/2	1/2	1/2	1/2	1/2	1/2	1/2	24,000
1 3/8	1 3/8	1 5/8	1 1/8	1 1/8	1 3/8	1 3/8	1 3/8	1 5/8	1 1/8	1 1/8	1 3/8	1 3/8	1 3/8	1 5/8	3/8	1/2	1/2	1/2	1/2	1/2	1/2	1/2	1/2	1/2	1/2	30,000
1 3/8	1 3/8	1 5/8	1 1/8	1 3/8	1 3/8	1 3/8	1 3/8	1 5/8	1 1/8	1 3/8	1 3/8	1 3/8	1 3/8	1 5/8	1/2	1/2	1/2	1/2	1/2	1/2	1/2	1/2	5/8	5/8	5/8	36,000
1 5/8	1 5/8	1 5/8	1 1/8	1 3/8	1 3/8	1 3/8	1 5/8	1 5/8	1 1/8	1 3/8	1 3/8	1 3/8	1 5/8	1 5/8	1/2	1/2	1/2	1/2	1/2	5/8	5/8	5/8	5/8	5/8	5/8	42,000
1 5/8	1 5/8	1 5/8	1 1/8	1 3/8	1 3/8	1 3/8	1 5/8	1 5/8	1 1/8	1 3/8	1 3/8	1 3/8	1 5/8	1 5/8	1/2	1/2	1/2	5/8	5/8	5/8	5/8	5/8	5/8	5/8	5/8	48,000
1 5/8	1 5/8	1 5/8	1 3/8	1 3/8	1 3/8	1 5/8	1 5/8	2 1/8	1 3/8	1 3/8	1 3/8	1 5/8	1 5/8	2 1/8	1/2	1/2	1/2	5/8	5/8	5/8	5/8	5/8	5/8	5/8	5/8	54,000
1 5/8	1 5/8	2 1/8	1 3/8	1 3/8	1 5/8	1 5/8	1 5/8	2 1/8	1 3/8	1 3/8	1 5/8	1 5/8	1 5/8	2 1/8	1/2	1/2	5/8	5/8	5/8	5/8	5/8	5/8	5/8	5/8	5/8	60,000
1 5/8	1 5/8	2 1/8	1 3/8	1 5/8	1 5/8	1 5/8	1 5/8	2 1/8	1 3/8	1 5/8	1 5/8	1 5/8	1 5/8	2 1/8	1/2	1/2	5/8	5/8	5/8	5/8	5/8	5/8	5/8	5/8	5/8	66,000
1 5/8	1 5/8	2 1/8	1 3/8	1 5/8	1 5/8	1 5/8	1 5/8	2 1/8	1 3/8	1 5/8	1 5/8	1 5/8	1 5/8	2 1/8	1/2	5/8	5/8	5/8	5/8	5/8	5/8	5/8	5/8	5/8	5/8	72,000
1 5/8	2 1/8	2 1/8	1 5/8	1 5/8	1 5/8	1 5/8	2 1/8	2 1/8	1 5/8	1 5/8	1 5/8	1 5/8	2 1/8	2 1/8	5/8	5/8	5/8	5/8	5/8	5/8	5/8	5/8	5/8	7/8	7/8	78,000
2 1/8	2 1/8	2 1/8	1 5/8	1 5/8	1 5/8	2 1/8	2 1/8	2 1/8	1 5/8	1 5/8	1 5/8	2 1/8	2 1/8	2 1/8	5/8	5/8	5/8	5/8	5/8	7/8	7/8	7/8	7/8	7/8	7/8	84,000
2 1/8	2 1/8	2 5/8	1 5/8	2 1/8	2 1/8	2 1/8	2 1/8	2 5/8	1 5/8	1 5/8	2 1/8	2 1/8	2 1/8	2 5/8	5/8	5/8	5/8	7/8	7/8	7/8	7/8	7/8	7/8	7/8	7/8	90,000
2 1/8	2 5/8	2 5/8	1 5/8	2 1/8	2 1/8	2 1/8	2 5/8	2 5/8	1 5/8	2 1/8	2 1/8	2 1/8	2 5/8	2 5/8	5/8	5/8	7/8	7/8	7/8	7/8	7/8	7/8	7/8	7/8	7/8	120,000
2 5/8	2 5/8	2 5/8	2 1/8	2 1/8	2 1/8	2 5/8	2 5/8	2 5/8	2 1/8	2 1/8	2 5/8	2 5/8	2 5/8	2 5/8	5/8	7/8	7/8	7/8	7/8	7/8	7/8	7/8	1 1/8	1 1/8	1 1/8	150,000
2 5/8	2 5/8	3 1/8	2 1/8	2 1/8	2 5/8	2 5/8	2 5/8	3 1/8	2 1/8	2 1/8	2 5/8	2 5/8	2 5/8	3 1/8	7/8	7/8	7/8	7/8	7/8	7/8	1 1/8	1 1/8	1 1/8	1 1/8	1 1/8	180,000
2 5/8	3 1/8	3 1/8	2 1/8	2 5/8	2 5/8	2 5/8	3 1/8	3 1/8	2 1/8	2 5/8	2 5/8	2 5/8	3 1/8	3 1/8	7/8	7/8	7/8	1 1/8	1 1/8	1 1/8	1 1/8	1 1/8	1 1/8	1 1/8	1 1/8	210,000
2 5/8	3 1/8	3 1/8	2 5/8	2 5/8	2 5/8	3 1/8	3 1/8	3 5/8	2 5/8	2 5/8	2 5/8	3 1/8	3 1/8	3 5/8	7/8	7/8	1 1/8	1 1/8	1 1/8	1 1/8	1 1/8	1 1/8	1 3/8	1 3/8	1 3/8	240,000
3 1/8	3 5/8	3 5/8	2 5/8	2 5/8	3 1/8	3 1/8	3 5/8	4 1/8	2 5/8	2 5/8	3 1/8	3 5/8	3 5/8	4 1/8	7/8	1 1/8	1 1/8	1 1/8	1 1/8	1 3/8	1 3/8	1 3/8	1 3/8	1 3/8	1 3/8	300,000
3 5/8	3 5/8	4 1/8	2 5/8	3 1/8	3 1/8	3 5/8	3 5/8	4 1/8	2 5/8	3 1/8	3 5/8	3 5/8	4 1/8	4 1/8	1 1/8	1 1/8	1 1/8	1 3/8	1 3/8	1 3/8	1 3/8	1 3/8	1 5/8	1 5/8	1 5/8	360,000
3 5/8	3 5/8	4 1/8	3 1/8	3 5/8	3 5/8	4 1/8	4 1/8	4 1/8	3 1/8	3 5/8	3 5/8	4 1/8	4 1/8	4 1/8	1 1/8	1 1/8	1 3/8	1 3/8	1 3/8	1 5/8	1 5/8	1 5/8	1 5/8	1 5/8	1 5/8	480,000
3 5/8	3 5/8	4 1/8	3 1/8	3 5/8	3 5/8	4 1/8	4 1/8	5 1/8	3 1/8	3 5/8	3 5/8	4 1/8	4 1/8	5 1/8	1 1/8	1 3/8	1 3/8	1 5/8	1 5/8	1 5/8	1 5/8	1 5/8	1 5/8	1 5/8	1 5/8	600,000

* NOTES:

- Sizes that are highlighted indicate maximum suction line sizes that should be used for risers. Riser size should not exceed horizontal size. Properly placed suction traps must also be used for adequate oil return. All sizes shown are for O.D. Type L copper tubing.
- Suction line sizes selected at pressure drop equivalent to 2°F. Reduce estimate of system capacity accordingly.
- Recommended liquid line size may increase with reverse cycle hot gas systems.
- If system load drops below 40% of design, consideration to installing double suction risers should be made.

Table 25. Pressure Loss of Liquid Refrigerants in Liquid Line Risers (Expressed in Pressure Drop, PSIG, and Subcooling Loss, °F).

Refrigerant	Liquid Line Rise in Feet																	
	10'		15'		20'		25'		30'		40'		50'		75'		100'	
	PSIG	°F	PSIG	°F	PSIG	°F	PSIG	°F	PSIG	°F	PSIG	°F	PSIG	°F	PSIG	°F	PSIG	°F
R-22	4.8	1.6	7.3	2.3	9.7	3.1	12.1	3.8	14.5	4.7	19.4	6.2	24.2	8.0	36.3	12.1	48.4	16.5
R-134a	4.9	2.0	7.4	2.9	9.8	4.1	12.3	5.2	14.7	6.3	19.7	8.8	24.6	11.0	36.8	17.0	49.1	23.7
R-507, R-404A	4.1	1.1	6.1	1.6	8.2	2.1	10.2	2.7	12.2	3.3	16.3	4.1	20.4	5.6	30.6	8.3	40.8	11.8

Based on 110°F liquid temperature at bottom of riser.

Table 26. Equivalent Feet of Pipe Due to Valve and Fitting Friction

Copper Tube, O.D., Type "L"	1/2	5/8	7/8	1 1/8	1 3/8	1 5/8	2 1/8	2 5/8	3 1/8	3 5/8	4 1/8	5 1/8	6 1/8
Globe Valve (Open)	14	16	22	28	36	42	57	69	83	99	118	138	168
Angle Valve (Open)	7	9	12	15	18	21	28	34	42	49	57	70	83
90° Turn Through Tee	3	4	5	6	8	9	12	14	17	20	22	28	34
Tee (Straight Through) or Sweep Below	.75	1	1.5	2	2.5	3	3.5	4	5	6	7	9	11
90° Elbow or Reducing Tee (Straight Through)	1	2	2	3	4	4	5	7	8	10	12	14	16

Table 27. Recommended Remote Condenser Line Sizes

Net Evaporator Capacity	Total Equiv. Length	R-134a		R-22		R507 & R-404A	
		Discharge Line (O.D.)	Liquid Line Cond. to Receiver (O.D.)	Discharge Line (O.D.)	Liquid Line Cond. to Receiver (O.D.)	Discharge Line (O.D.)	Liquid Line Cond. to Receiver (O.D.)
3,000	50	3/8	3/8	3/8	3/8	3/8	3/8
	100	3/8	3/8	3/8	3/8	3/8	3/8
6,000	50	1/2	3/8	3/8	3/8	1/2	3/8
	100	1/2	3/8	1/2	3/8	1/2	3/8
9,000	50	1/2	3/8	1/2	3/8	1/2	3/8
	100	5/8	3/8	1/2	3/8	1/2	3/8
12,000	50	5/8	3/8	1/2	3/8	1/2	3/8
	100	5/8	1/2	5/8	3/8	5/8	1/2
18,000	50	5/8	1/2	5/8	3/8	5/8	1/2
	100	7/8	1/2	5/8	3/8	7/8	1/2
24,000	50	7/8	1/2	5/8	3/8	5/8	1/2
	100	7/8	1/2	7/8	1/2	7/8	5/8
36,000	50	7/8	1/2	7/8	1/2	7/8	5/8
	100	1 1/8	5/8	7/8	5/8	7/8	7/8
48,000	50	7/8	5/8	7/8	5/8	7/8	5/8
	100	1 1/8	7/8	7/8	7/8	1 1/8	7/8
60,000	50	1 1/8	5/8	7/8	5/8	7/8	7/8
	100	1 1/8	7/8	1 1/8	7/8	1 1/8	7/8
72,000	50	1 1/8	7/8	7/8	7/8	1 1/8	7/8
	100	1 3/8	7/8	1 1/8	7/8	1 1/8	1 1/8
90,000	50	1 1/8	7/8	1 1/8	7/8	1 1/8	7/8
	100	1 3/8	1 1/8	1 1/8	7/8	1 1/8	1 1/8
120,000	50	1 3/8	7/8	1 1/8	7/8	1 1/8	1 1/8
	100	1 5/8	1 1/8	1 3/8	1 1/8	1 3/8	1 3/8
180,000	50	1 5/8	1 1/8	1 3/8	1 1/8	1 3/8	1 3/8
	100	1 5/8	1 3/8	1 5/8	1 3/8	1 5/8	1 5/8
240,000	50	1 5/8	1 3/8	1 3/8	1 3/8	1 5/8	1 3/8
	100	2 1/8	1 5/8	1 5/8	1 3/8	2 1/8	1 5/8
300,000	50	2 1/8	1 3/8	1 5/8	1 3/8	1 5/8	1 5/8
	100	2 1/8	1 5/8	2 1/8	1 5/8	2 1/8	2 1/8
360,000	50	2 1/8	1 5/8	1 5/8	1 5/8	2 1/8	1 5/8
	100	2 1/8	2 1/8	2 1/8	2 1/8	2 1/8	2 1/8
480,000	50	2 1/8	2 1/8	2 1/8	1 5/8	2 1/8	2 1/8
	100	2 5/8	2 1/8	2 1/8	2 1/8	2 1/8	2 5/8
600,000	50	2 5/8	2 1/8	2 1/8	2 1/8	2 1/8	2 1/8
	100	2 5/8	2 5/8	2 5/8	2 5/8	2 5/8	2 5/8
720,000	50	2 5/8	2 1/8	2 1/8	2 1/8	2 1/8	2 5/8
	100	3 1/8	2 5/8	2 5/8	2 5/8	2 5/8	3 1/8
840,000	50	2 5/8	2 5/8	2 1/8	2 1/8	2 5/8	2 5/8
	100	3 1/8	3 1/8	2 5/8	2 5/8	2 5/8	3 1/8
960,000	50	2 5/8	2 5/8	2 5/8	2 5/8	2 5/8	2 5/8
	100	3 1/8	3 1/8	2 5/8	3 1/8	3 1/8	3 5/8
1,080,000	50	3 1/8	2 5/8	2 5/8	2 5/8	2 5/8	3 1/8
	100	3 1/8	3 1/8	3 1/8	3 1/8	3 1/8	3 5/8
1,200,000	50	3 1/8	2 5/8	2 5/8	2 5/8	2 5/8	3 1/8
	100	3 5/8	3 5/8	3 1/8	3 1/8	3 5/8	4 1/8
1,440,000	50	3 1/8	3 1/8	2 5/8	3 1/8	3 1/8	3 5/8
	100	3 5/8	3 5/8	3 1/8	3 5/8	3 5/8	4 1/8
1,680,000	50	3 5/8	3 1/8	3 1/8	3 1/8	3 1/8	3 5/8
	100	4 1/8	4 1/8	3 5/8	3 5/8	3 5/8	4 1/8

Table 28. Weight of Refrigerants in Copper Lines During Operation (Pounds per 100 lineal feet of type "L" tubing).

Line Size O.D. in Inches	Refrigerant	Liquid Line	Hot Gas Line	Suction Line at Suction Temperature				
				-40°F	-20°F	0°F	+20°F	+40°F
3/8	134a	4.0	.15	.01	.01	.02	.04	.06
	22	3.9	.22	.02	.03	.04	.06	.08
	R507, 404A	3.4	.31	.03	.04	.06	.09	.13
1/2	134a	7.4	.30	.01	.03	.04	.07	.11
	22	7.4	.41	.03	.05	.07	.11	.15
	R507, 404A	6.4	.58	.04	.07	.13	.16	.24
5/8	134a	11.9	.47	.02	.05	.07	.12	.17
	22	11.8	.65	.05	.08	.12	.17	.25
	R507, 404A	10.3	.93	.07	.11	.17	.25	.35
7/8	134a	24.7	.99	.05	.10	.15	.24	.36
	22	24.4	1.35	.10	.16	.24	.36	.51
	R507, 404A	21.2	1.92	.15	.23	.37	.51	.72
1 1/8	134a	42.2	1.70	.08	.17	.26	.41	.60
	22	41.6	2.30	.17	.28	.42	.61	.87
	R507, 404A	36.1	3.27	.26	.39	.63	.86	1.24
1 3/8	134a	64.2	2.57	.14	.26	.40	.61	1.91
	22	63.5	3.50	.27	.42	.64	.93	1.33
	R507, 404A	55.0	4.98	.40	.58	.95	1.32	1.87
1 5/8	134a	90.9	3.65	.20	.37	.57	.87	1.30
	22	90.0	4.96	.37	.59	.90	1.33	1.88
	R507, 404A	78.0	7.07	.56	.82	1.35	1.86	2.64
2 1/8	134a	158	6.34	.34	.64	.98	1.51	2.24
	22	156	8.61	.65	1.03	1.57	2.30	3.26
	R507, 404A	134	12.25	.98	1.43	2.35	3.23	4.58
2 5/8	134a	244	9.78	.52	.99	1.51	2.32	3.47
	22	241	13.70	1.01	1.59	2.42	3.54	5.03
	R507, 404A	209	18.92	1.51	2.21	3.62	5.00	7.07
3 1/8	134a	348	13.97	.75	1.41	2.16	3.31	4.96
	22	344	18.95	1.44	2.28	3.45	5.05	7.18
	R507, 404A	298	27.05	2.16	3.15	5.17	7.14	9.95
3 5/8	134a	471	18.90	.99	1.91	2.92	4.48	6.69
	22	465	25.60	1.94	3.08	4.67	6.83	9.74
	R507, 404A	403	36.50	2.92	4.25	6.97	19.65	13.67
4 1/8	134a	612	24.56	1.29	2.49	3.81	5.84	8.75
	22	605	33.40	2.53	4.01	6.08	8.90	12.70
	R507, 404A	526	47.57	3.80	5.55	9.09	12.58	17.80

Table 29.

Fahrenheit – Celsius Temperature Conversion Chart

The number in bold type-face in the center column refers to the temperature, either Celsius or Fahrenheit, which is to be converted to the other scale. If converting Fahrenheit to Celsius

the equivalent temperature will be found in the left column. If converting Celsius to Fahrenheit, the equivalent temperature will be found in the column on the right.

Temperature			Temperature			Temperature			Temperature		
Celsius	°C. or °F.	Fahrenheit	Celsius	°C. or °F.	Fahrenheit	Celsius	°C. or °F.	Fahrenheit	Celsius	°C. or °F.	Fahrenheit
-40.0	-40	-40.0	-6.7	+20	+68.0	+26.7	+80	+176.0	+60.0	+140	+284.0
-39.4	-39	-38.2	-6.1	+21	+69.8	+27.2	+81	+177.8	+60.6	+141	+285.8
-38.9	-38	-36.4	-5.5	+22	+71.6	+27.8	+82	+179.6	+61.1	+142	+287.6
-38.3	-37	-34.6	-5.0	+23	+73.4	+28.3	+83	+181.4	+61.7	+143	+289.4
-37.8	-36	-32.8	-4.4	+24	+75.2	+28.9	+84	+183.2	+62.2	+144	+291.2
-37.2	-35	-31.0	-3.9	+25	+77.0	+29.4	+85	+185.0	+62.8	+145	+293.0
-36.7	-34	-29.2	-3.3	+26	+78.8	+30.0	+86	+186.8	+63.3	+146	+294.8
-36.1	-33	-27.4	-2.8	+27	+80.6	+30.6	+87	+186.6	+63.9	+147	+296.6
-35.6	-32	-25.6	-2.2	+28	+82.4	+31.1	+88	+190.4	+64.4	+148	+298.4
-35.0	-31	-23.8	-1.7	+29	+84.2	+31.7	+89	+192.2	+65.0	+149	+300.2
-34.4	-30	-22.0	-1.1	+30	+86.0	+32.2	+90	+194.0	+65.6	+150	+302.0
-33.9	-29	-20.2	-0.6	+31	+87.8	+32.8	+91	+195.8	+66.1	+151	+303.8
-33.3	-28	-18.4	0	+32	+89.6	+33.3	+92	+197.6	+66.7	+152	+305.6
-32.8	-27	-16.6	+0.6	+33	+91.4	+33.9	+93	+199.4	+67.2	+153	+307.4
-32.2	-26	-14.8	+1.1	+34	+93.2	+34.4	+94	+201.2	+67.8	+154	+309.2
-31.7	-25	-13.0	+1.7	+35	+95.0	+35.0	+95	+203.0	+68.3	+155	+311.0
-31.1	-24	-11.2	+2.2	+36	+96.8	+35.6	+96	+204.8	+68.9	+156	+312.8
-30.6	-23	-9.4	+2.8	+37	+98.6	+36.1	+97	+206.6	+69.4	+157	+314.6
-30.0	-22	-7.6	+3.3	+38	+100.4	+36.7	+98	+208.4	+70.0	+158	+316.4
-29.4	-21	-5.8	+3.9	+39	+102.2	+37.2	+99	+210.2	+70.6	+159	+318.2
-28.9	-20	-4.0	+4.4	+40	+104.0	+37.8	+100	+212.0	+71.1	+160	+320.0
-28.3	-19	-2.2	+5.0	+41	+105.8	+38.3	+101	+213.8	+71.7	+161	+321.8
-27.8	-18	-0.4	+5.5	+42	+107.6	+38.9	+102	+215.6	+72.2	+162	+323.6
-27.2	-17	+1.1	+6.1	+43	+109.4	+39.4	+103	+217.4	+72.8	+163	+325.4
-26.7	-16	+3.2	+6.7	+44	+111.2	+40.0	+104	+219.2	+73.3	+164	+327.2
-26.1	-15	+5.0	+7.2	+45	+113.0	+40.6	+105	+221.0	+73.9	+165	+329.0
-25.6	-14	+6.8	+7.8	+46	+114.8	+41.1	+106	+222.8	+74.4	+166	+330.8
-25.0	-13	+8.6	+8.3	+47	+116.6	+41.7	+107	+224.6	+75.0	+167	+332.6
-24.4	-12	+10.4	+8.9	+48	+118.4	+42.2	+108	+226.4	+75.6	+168	+334.4
-23.9	-11	+12.2	+9.4	+49	+120.2	+42.8	+109	+228.2	+76.1	+169	+336.2
-23.3	-10	+14.0	+10.0	+50	+122.0	+43.3	+110	+230.0	+76.7	+170	+338.0
-22.8	-9	+15.8	+10.6	+51	+123.8	+43.9	+111	+231.8	+77.2	+171	+339.8
-22.2	-8	+17.6	+11.1	+52	+125.6	+44.4	+112	+233.6	+77.8	+172	+341.6
-21.7	-7	+19.4	+11.7	+53	+127.4	+45.0	+113	+235.4	+78.3	+173	+343.4
-21.1	-6	+21.2	+12.2	+54	+129.2	+45.6	+114	+237.2	+78.9	+174	+345.2
-20.6	-5	+23.0	+12.8	+55	+131.0	+46.1	+115	+239.0	+79.4	+175	+347.0
-20.0	-4	+24.8	+13.3	+56	+132.8	+46.7	+116	+240.8	+80.0	+176	+348.8
-19.4	-3	+26.6	+13.9	+57	+134.6	+47.2	+117	+242.6	+80.6	+177	+350.6
-18.9	-2	+28.4	+14.4	+58	+136.4	+47.8	+118	+244.4	+81.1	+178	+352.4
-18.3	-1	+30.2	+15.0	+59	+138.2	+48.3	+119	+246.2	+81.7	+179	+354.2
-17.8	0	+32	+15.6	+60	+140.0	+48.9	+120	+248.0	+82.2	+180	+356.0
-17.2	+1	+33.8	+16.1	+61	+141.8	+49.4	+121	+249.8	+82.8	+181	+357.8
-16.7	+2	+35.6	+16.7	+62	+143.6	+50.0	+122	+251.6	+83.3	+182	+359.6
-16.1	+3	+35.4	+17.2	+63	+145.4	+50.6	+123	+253.4	+83.9	+183	+361.4
-15.6	+4	+39.2	+17.8	+64	+147.2	+51.1	+124	+255.2	+84.4	+184	+363.2
-15.0	+5	+41.0	+18.3	+65	+149.0	+51.7	+125	+257.0	+85.0	+185	+365.0
-14.4	+6	+42.8	+18.9	+66	+150.8	+52.2	+126	+258.8	+85.6	+186	+366.8
-13.9	+7	+44.6	+19.4	+67	+152.6	+52.8	+127	+260.6	+86.1	+187	+368.6
-13.3	+8	+46.4	+20.0	+68	+154.4	+53.3	+128	+262.4	+86.7	+188	+370.4
-12.8	+9	+48.2	+20.6	+69	+156.2	+53.9	+129	+264.2	+87.2	+189	+372.2
-12.2	+10	+50.0	+21.1	+70	+158.0	+54.4	+130	+266.0	+87.8	+190	+374.0
-11.7	+11	+51.8	+21.7	+71	+159.8	+55.0	+131	+267.8	+88.3	+191	+375.8
-11.1	+12	+53.6	+22.2	+72	+161.6	+55.6	+132	+269.6	+88.9	+192	+377.6
-10.6	+13	+55.4	+22.8	+73	+163.4	+56.1	+133	+271.4	+89.4	+193	+379.4
-10.0	+14	+57.2	+23.3	+74	+165.2	+56.7	+134	+273.2	+90.0	+194	+381.2
-9.4	+15	+59.0	+23.9	+75	+167.0	+57.2	+135	+275.0	+90.6	+195	+383.0
-8.9	+16	+60.8	+24.4	+76	+168.8	+57.8	+136	+276.8	+91.1	+196	+384.8
-8.3	+17	+62.6	+25.0	+77	+170.6	+58.3	+137	+278.6	+91.7	+197	+386.6
-7.8	+18	+64.4	+25.6	+78	+172.4	+58.9	+138	+280.4	+92.2	+198	+388.4
-7.2	+19	+66.2	+26.1	+79	+174.2	+59.4	+139	+282.2	+92.8	+199	+390.2

Reprinted by permission from 1972 ASHRAE Handbook of Fundamentals.

Table 30.
Conversion Factors (constant)

Water	500 = 8.33 lbs./gal. x 60 min,	– (Converts GPM to lbs./hr.)
Air	4.5 = $\frac{60 \text{ min}}{13.35 \text{ Cu. Ft./lb.}}$	– (Converts CFM to lbs./hr.)
	1.08 = $4.5 \times 0.241 \text{ BTU/lb./}^\circ\text{F.}$	– (lbs./hr. x Sp. Ht. of Air)
	0.68 = $\frac{4.5 \times 1054.3 \text{ BTU/lb.}}{7000 \text{ gr/lb.}}$	– (4.5 combined with heat of vaporization of water at 70°F. and grains per pound of water)
Water Heating, Cooling & Heat Reclaim Coils, Water Chillers, Condensers, etc.	$Q = 500 \times \text{GPM} \times T\Delta$	= BTU/hr.
	$\Delta T = \frac{Q}{500 \times \text{GPM}}$	
	For brines, $Q = 500 \times \text{GPM} \times T \times \Delta(\text{Sp. Ht.} \times \text{Sp. Gr. of Brine})$	

Properties of Water at 39.2 °F.

Density of Water	= 62.4 lbs./Cu. Ft.
Specific Heat of Water	= 1 BTU/lb./°F.
Latent Heat of Vaporization	= 970 BTU/lb. at 212°F. & Atm.
Specific Heat of Ice	= 0.5 BTU/lb./°F.
Latent Heat of Fusion	= 144 BTU/lb.
1 Gallon of Water	= 8.33 lbs.
1 Pound of Water	= 7000 Grains

Table 31.
Single Phase Loads
Ohm's Law for direct current

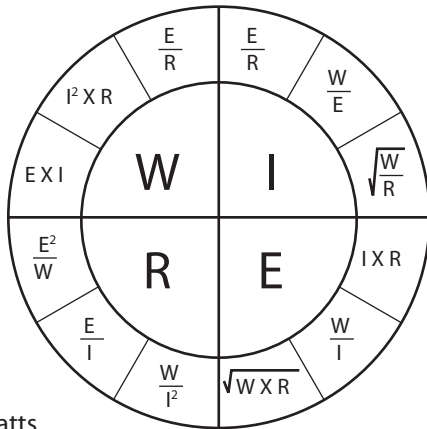

W = Watts
I = Current (Amperes)
E = Electromotive Force (Volts)
R = Resistance (Ohms)

To obtain any values in the center circle, for Direct or Alternating Current, perform the operation indicated in one segment of the adjacent outer circle.

Air Coils

$Q \text{ Sensible} = 1.08 \times \text{CFM} \times T\Delta = \text{BTU/hr.}$
 $Q \text{ Latent} = 0.68 \times \text{CFM} \times \Delta H = \text{BTU/hr.}$
 $Q \text{ Total} = 4.5 \times \text{CFM} \times \Delta H = \text{BTU/hr.}$

$\text{lb./hr. Condensate} = \frac{4.5 \times \text{CFM} \times \Delta H \text{ Grains}}{7000 \text{ grains/lb}}$

$\text{SHR Sensible Heat Ratio} = \frac{Q \text{ Sensible}}{Q \text{ Total}}$

Heat Transmission

$Q \text{ Total} = U \times A \text{ Surface} \times T\Delta = \text{BTU/hr.}$

Product

$\text{Sensible Heat in BTU/hr.} = \text{lbs/hr.} \times \text{Sp. Ht.} \times T\Delta$
 $\text{Latent Heat in BTU/hr.} = \text{lbs/hr.} \times \text{Lt. Ht. in Btu/lb.}$
 $\text{Heat of Resp. in BTU/hr} = \text{lbs} \times \text{Heat of Respiration in BTU/lb./hr.}$

All conversion factors used in standard calculations must be corrected for other than standard properties

Nomenclature

- Q = Heat Flow in BTU/hr.
- T = Temperature in °F. (TΔ = temp. diff.)
- A = Area in Sq. Ft.
- U = Coef. of Heat Transfer in BTU/hr./Sq.Ft./°F.
- H = Total heat of air at wet bulb temp. BTU/lb.
- ΔH = Enthalpy difference between entering & leaving air
- SH = Specific humidity in grains of moisture/lb. of dry air (ΔH = Specific humidity difference for entering and leaving air)
- CFM = Cu. Ft./min.
- GPM = Gal/min.

3 Phase Delta Loads

3 Ø Balanced Loads = P₁ + P₂ + P₃

Total Line Current = Total Power (Balanced Load)

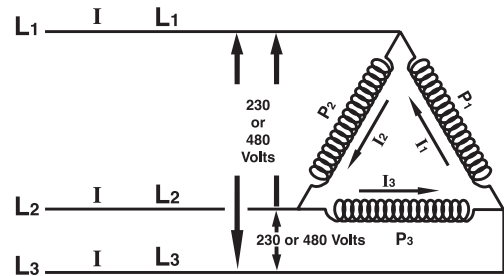

If the phase are unbalanced, each of the phase will differ from the others:

FORMULAE: $I_{L1} = \sqrt{\frac{1}{3} I_1^2 + (I_1 \times I_2)}$
 $I_{L2} = \sqrt{\frac{1}{2} I_2^2 + (I_2 \times I_3)}$
 $I_{L3} = \sqrt{\frac{1}{3} I_1^2 + (I_1 \times I_3)}$

Table 32.
English Conversion Factors & Data

To Convert Measurements		
From	To	Multiply By
Cubic Feet	Cubic Inches	1728
Cubic Inches	Cubic Feet	0.00058
Cubic Feet	Gallons	7.48
Gallons	Cubic Feet	0.1337
Cubic Inches	Gallons	0.00433
Gallons	Cubic Inches	231
Barrels	Gallons	42
Gallons	Barrels	0.0238
Imperial Gallons	U.S. Gallons	1.2009
U.S. Gallons	Imperial Gallons	0.8326
Feet	Inches	12
Inches	Feet	0.0833
Square Feet	Square Inches	144
Square Inches	Square Feet	0.00695
Short Tons	Pounds	2000
Liters	U.S. Gallons	0.2642

Table 33.
English to Metric Conversion Factors

To Convert Measurements		
From	To	Multiply By
Cubic Feet	Cubic Centimeters	28317
Cubic Inches	Cubic Centimeters	16.387
Cubic Feet	Liters	28.32
Gallons	Liters	3.7854
Cubic Inches	Liters	0.0164
Gallons	Cubic Centimeters	3785.4
Barrels	Cubic Meters	1.0551
Imperial Gallons	Cubic Meters	0.0045461
U.S. Gallons	Cubic Meters	0.0037854
Feet	Meters	0.3048
Inches	Meters	0.0254
Square Feet	Square Meters	0.0929
Square Inches	Square Centimeters	6.452
Ton (Short, 2000lb.)	Kilograms	907.2
Liter	Cubic Meter	0.0001
Pounds	Kilograms	0.45359

To Convert Pressure (at 32°F.)		
From	To	Multiply By
Inches of Water	Pounds per Sq. Inch	0.03612
Pounds per Sq. Inch	Inches of Water	27.866
Feet of Water	Pounds per Sq. Inch	0.4334
Pounds per Sq. Inch	Feet of Water	2.307
Inches of Mercury	Pounds per Sq. Inch	0.4912
Pounds per Sq. Inch	Inches of Mercury	2.036
Atmospheres	Pounds per Sq. Inch	14.696
Pounds per Sq. Inch	Atmosphere	0.06804

To Convert Pressure (at 32°F.)		
From	To	Multiply By
Inches of Water	Newton/Sq. Meter	249.082
Pounds per Sq. Inch	Newton/Sq. Meter	6894.8
Feet of Water	Newton/Sq. Meter	2988.98
Pounds per Sq. Inch	Kilograms/Sq. Cent.	0.07031
Inches of Mercury	Newton/Sq. Meter	3386.4
Pounds per Sq. Inch	Dyne/Sq. Cent.	68948
Atmospheres	Newton/Sq. Meter	101325
Pascal	Newton/Sq. Meter	1

To Convert Power		
From	To	Multiply By
Horsepower	Metric Horsepower	1.014
Horsepower	Ft./Pounds per Min.	33000
Horsepower	Kilowatts	0.746
Kilowatts	Horsepower	1.3404
British Thermal Units	Foot/Pounds	778.177
Foot/Pounds	British Thermal Units	0.001285
British Thermal Units	Horsepower Hours	0.0003927
Horsepower Hours	British Thermal Units	2544.1
British Thermal Units	Kilowatt Hours	0.0002928
Kilowatt	British Thermal Units	3415
Watt Hour	British Thermal Units	3.415

To Convert Power		
From	To	Multiply By
Horsepower	Watt	745.7
British Thermal Units	Joule	1054.35
Foot – Pounds	Joule	1.3558
British Thermal Units	Calorie	252.0
British Thermal Units	Watt Second	1054.35
Watt – Second	Joule	1
Calorie	Joule	4.184
Watt Hours	Joule	3600
Kilocalorie/Minute	Watt	69.73
Ton (Refrigerated)	Watt	3516.8
BTU/Hour	Watt	0.29288
BTU/In./Hr. Ft. ² °F.	Watt/Meter °K.	0.14413
BTU/Hr. at 10°F. T.D.	Kcal/Hr. at 6°C. T.D.	0.252
BTU/Hr. at 15°F. T.D.	Kcal/Hr. at 8°C. T.D.	0.252

Volume – Weight Conversions	Wt. lbs.
1 Cubic Foot of Water	62.4*
1 Cubic Inch of Water	0.0361*
1 Gallon of Water	8.33*
1 Cubic Foot of Air	0.075†
1 Cubic inch of Steel	0.284
1 Cubic Foot of Brick (Building)	112-120
1 Cubic Foot of Concrete	120-140
1 Cubic Foot of Earth	70-120

* at 32°F.
† at 70°F. and 29.92" Hg.

Volume – Weight Conversions	Wt. Kilograms
1 Cubic Foot of Water	28.3*
1 Cubic Inch of Water	0.0164*
1 Gallon of Water	3.788*
1 Cubic Foot of Air	0.034†
1 Cubic inch of Steel	0.1288
1 Cubic Foot of Brick (Building)	51-54
1 Cubic Foot of Concrete	54-64
1 Cubic Foot of Earth	32-54

* at 32°F.
† at 70°F. and 29.92" Hg.

Use of the Psychrometric Chart

From two known properties of air, its condition can be located on the Psychrometric chart and all remaining properties can then be found by reading the appropriate scale.

Figure 1 Illustrates a condition plotted at the intersection of its dry bulb and wet bulb temperatures. The dry bulb temperature is represented on the chart by the vertical lines with its scale across the bottom. The wet bulb temperature is read along the saturation line and is represented on the chart by the solid diagonal lines. Enthalpy at a saturation, for a given wet bulb temperature is read from the diagonal scale at the left using the diagonal lines extending from the saturation line.

Figure 2 Illustrates a condition plotted at the intersection of its dry bulb temperature and relative humidity. Relative humidity is represented on the chart by the curved lines which are marked in percent relative humidity.

Figure 3 Illustrates a condition plotted at the intersection of its dry bulb and dew point temperatures. The dew point temperature is read along the saturation line at the intersection of the Horizontal Humidity line. The value of the specific humidity is read from the scales at the right in either pounds or grains of moisture per pound of dry air by selecting the appropriate scale.

Figure 4 Illustrates the determination of specific volume from the chart. Specific volume is represented by the broken diagonal lines marked in cubic feet per pound of dry air. Intermediate points are read by interpolation between the lines.

Figure 5 Illustrates the use of sensible heat factor to determine the air conditions required to satisfy a specified space temperature and load conditions. The sensible heat factor is the ratio of internal sensible heat to internal total heat load of the space being conditioned. A straight line from the sensible heat factor scale through the circled point of the chart to the slope line from the space condition point to the saturation line. Air supplied to the space at any temperature condition located on the ratio line (and in the proper volume) will satisfy the room load.

Example — Using the point which is circled on the Psychrometric Chart, the following values are obtained:

Dry Bulb Temperature	80.0°F
Wet Bulb Temperature	67.0°F
Dew Point Temperature	60.3°F
Relative Humidity	51.1%
Specific Humidity	
A) 0.01115 lbs./lb. dry air =	$\frac{78.1}{7000}$ SR/lb dry air
B) 78.1 grains/lb. dry air	
Enthalpy at saturation	31.62 BTU/lb. dry air
Specific Volume	13.83 Cu. Ft./lb. dry air

Figure 6 ... *Air Conditioned Process

1. Cooling and Dehumidification — A decrease in both dry bulb and specific humidity represented by a line sloping downward and to the left. Total heat content (both sensible and latent heat) is decreased.
2. Sensible Cooling — A decrease in dry bulb and sensible heat content represented by a horizontal line directed to the left

along the constant specific humidity line. Specific humidity and dew point remain constant.

3. Evaporating Cooling — (Air passed through spray water or wetted surface at wet bulb temperature) – A decrease in dry bulb (reduced sensible heat content) and an increase in dew point and specific humidity (increased latent heat content) represented by a line sloping upward and to the left following a constant wet bulb line – no change in total heat content.
4. Humidification — An increase in the specific humidity as a result of moisture added, represented by a line directed upward.
5. Heating and Humidification — An increase in both sensible heat and specific humidity, represented by a line sloping upward and to the right.
6. Sensible Heating — An increase in dry bulb and sensible heat content, represented by a horizontal line directed to the right along the constant specific humidity line, Specific humidity and dew point remain constant.
7. Chemical Drying — (Air passed through a chemical drying agent) – A decrease in dew point and specific humidity, represented by a line sloping downward and to the right.
8. Dehumidification — a decrease in the specific humidity as a result of removing moisture, represented by a line directed downward.

Definitions

Dry Bulb Temperature — The temperature indicated by a thermometer, not affected by the water vapor content air.

Wet Bulb Temperature — The temperature of air indicated by a wet bulb thermometer; the temperature at which water, by evaporating into air, can bring the air to saturation adiabatically at the same temperature.

Dew Point Temperature — The temperature to which water vapor in air must be reduced to produce condensation of the moisture contained therein.

Relative Humidity — The ratio of actual vapor pressure in the air to the vapor pressure of saturated air at the same dry bulb temperature.

Specific Humidity (Moisture Content of Humidity Ratio) — The weight of water vapor per pound of dry air.

Sensible Heat — Heat which when added or subtracted from the air changes only its temperature with no effect on specific humidity.

Latent Heat — Heat which effects a change of state without affecting temperature, as in evaporating or condensing moisture.

Enthalpy (Total Heat) — The sum of sensible and latent heat. In the chart, enthalpy represents units of total heat content above an arbitrary base in terms of BTU per pound of dry air.

Specific Volume — Volume per unit of weight, the reciprocal of density, in terms of cubic feet per pound of dry air.

Sensible Heat Factor — The ratio of internal sensible heat to internal total heat load.

Ratio Line — The line extending from the space condition to the saturation line at a slope determined by the sensible heat factor.

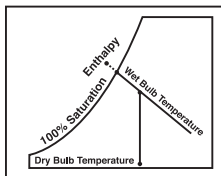

Fig 1 — Dry Bulb and Wet Bulb

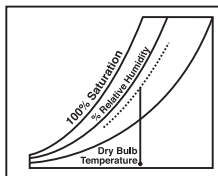

Fig 2 — Dry Bulb and Relative Humidity

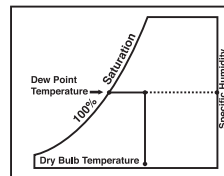

Fig 3 — Dry Bulb and Dew Point

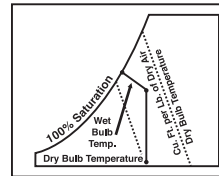

Fig 4 — Specific Volume

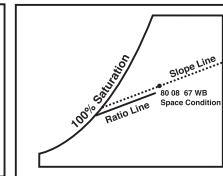

Fig 5 — Sensible Heat Factor

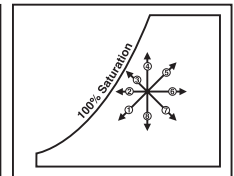
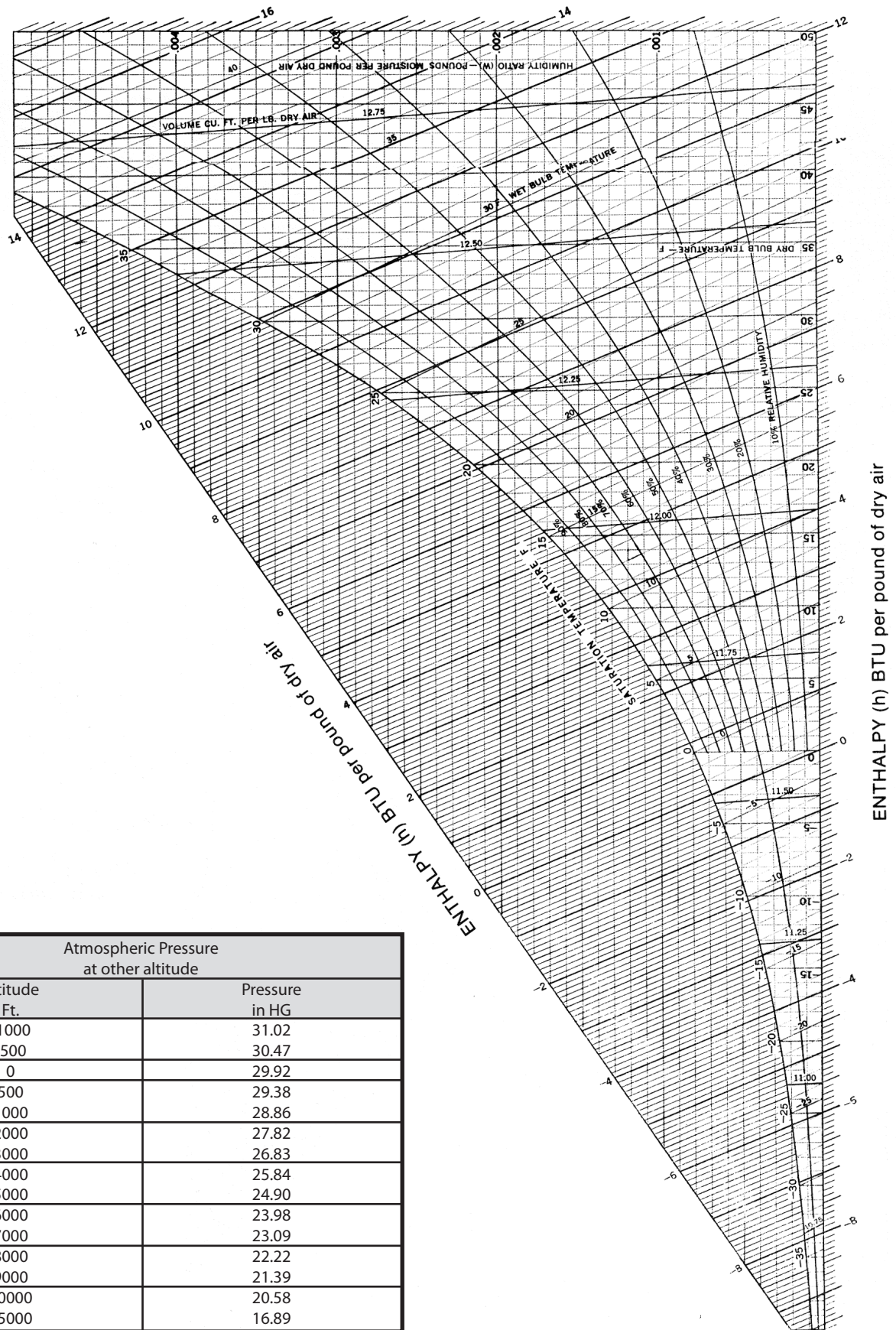

Fig 6 — Air Conditioning Process * (See Above)

Appendix — Charts
 Low Temperature Psychrometric Chart (-40 to 50°F)
 Standard Atmospheric Pressure of 29.921 in HG



Atmospheric Pressure at other altitude	
Altitude Ft.	Pressure in HG
-1000	31.02
-500	30.47
0	29.92
500	29.38
1000	28.86
2000	27.82
3000	26.83
4000	25.84
5000	24.90
6000	23.98
7000	23.09
8000	22.22
9000	21.39
10000	20.58
15000	16.89

Courtesy of ASHRAE — Reproduced by permission.

Appendix — Charts
 Medium Temperature Psychrometric Chart (32 to 130°F)
 Standard Atmospheric Pressure of 29.921 in HG

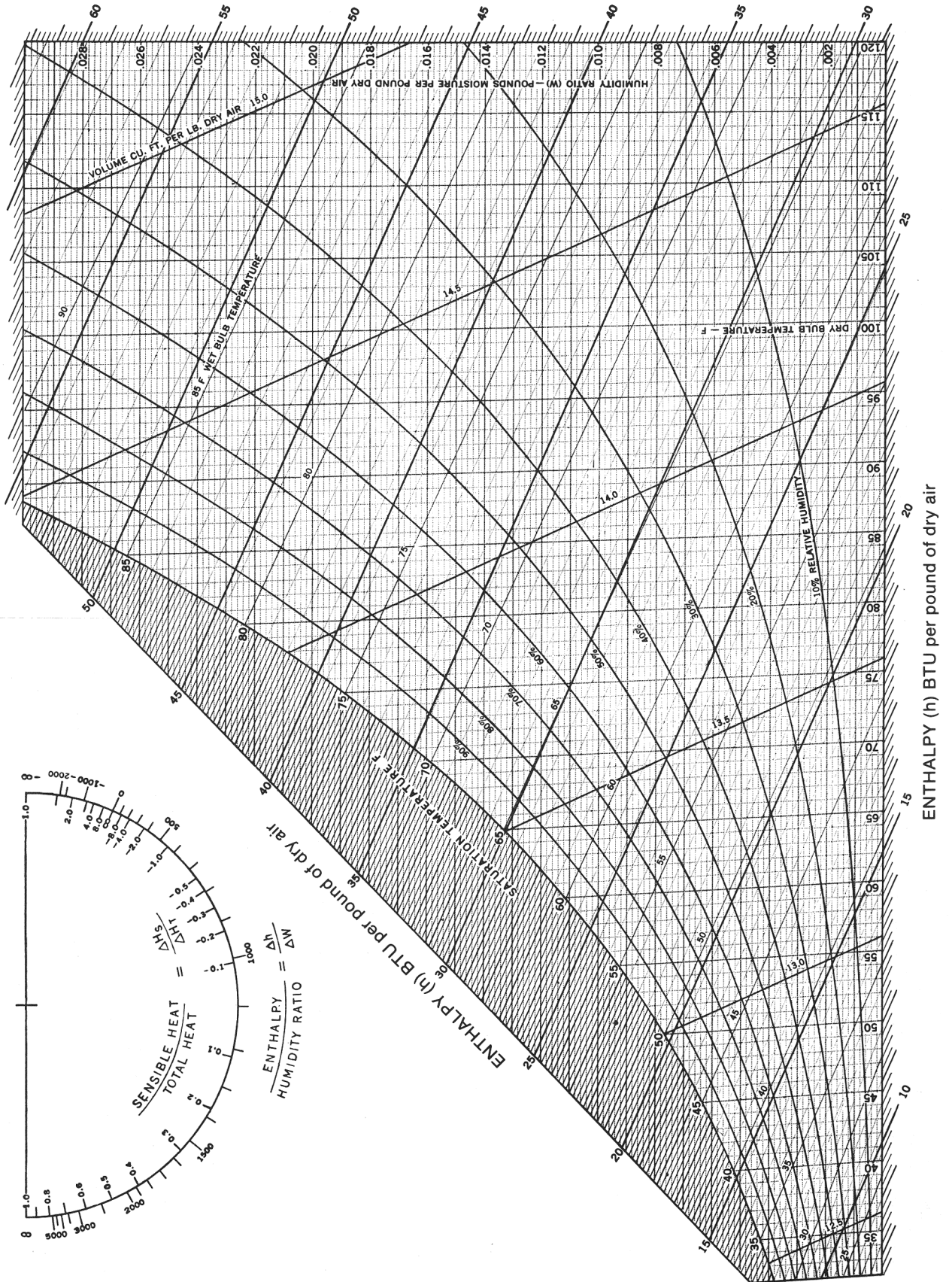

Courtesy of ASHRAE — Reproduced by permission.

Glossary of Refrigeration Terms

1. Accumulator - a shell placed in suction line for separating liquid refrigerant entrained in suction gas.
2. Air Changes - the amount of air leakage is sometimes computed by assuming a certain number of air changers per hour for each room, the number of changes assumed being dependent upon the type, use and location of the room.
3. Air Cooler, Forced Circulation - a factory-made encased assembly of elements by which heat is transferred from air to evaporating refrigerant.
4. Ambient Air - generally speaking, the air surrounding an object. In a domestic or commercial refrigerating system having an air-cooled condenser, the temperature of the air entering the condenser.
5. Back Pressure - loose terminology for suction pressure of refrigeration vapor in a system.
6. British Thermal Unit (BTU) - heat required to produce a temperature rise of 1 degree Fahrenheit in 1 lb. of water. The mean BTU is 1/180 of the energy required to heat water from 32°F. to 212°F.
7. Change of Air - introduction of new, cleansed or recirculated air to conditioned space, measured by the number of complete changes per unit time.
8. Chill - to apply refrigeration moderately, as to meats, without freezing.
9. Chilling Room - room where animal carcasses are cooled after dressing prior to cold storage.
10. Comfort Air Conditioning - the simultaneous control of all, or at least the first three, of the following factors affecting the physical and chemical conditions of the atmosphere within a structure for the purpose of human comfort; temperature, humidity, motion, distribution, dust, bacteria, odors, toxic gasses and ionization, most of which affect in greater or lesser degree human health or comfort.
11. Comfort Cooling - refrigeration for comfort as opposed to refrigeration for storage or manufacture.
12. Defrosting Cycle - a refrigeration cycle which permits cooling unit to defrost during off period.
13. Dehumidification - the conservation of water vapor from air by cooling below the dew point or removal of water vapor from air by chemical or physical methods.
14. Dehydration - the removal of water vapor from air by the use of absorbing materials. (2) The removal of water from stored goods.
15. Dew Point - temperature at which condensation starts if moist air is cooled at constant pressure with no loss or gain of moisture during the cooling process.
16. Differential (of a control) - the difference between cut-in and cut-out temperature or pressure.
17. Dry Bulb Temperature - temperature measured by ordinary thermometer (term used only to distinguish from wet-bulb temperature).
18. Duct - a conduit or tube used for conveying air or other gas.
19. Evaporator - the part of a system in which refrigerant liquid is vaporizing to produce refrigerant.
20. External Equalizer - in a thermostatic expansion valve, a tube connection from the chamber containing the evaporation pressure-actuated element of the valve to the outlet or the evaporator coil. A device to compensate for excessive pressure drop throughout the coil.
21. Flash Gas - the gas resulting from the instantaneous evaporation of refrigerant in a pressure-reducing device to cool the refrigerant to the evaporations temperature obtained at the reduces pressure.
22. Flooded System - system in which only part of the refrigerant passing over the heat transfer surface is evaporated, and the portion not evaporated is separated from the vapor and recirculated. In commercial systems, one controlled by a float valve.
23. Frost Back - the flooding of liquid from an evaporator into the suction line accompanied by frost formation in suction line in most cases.
24. Head Pressure - operating pressure measured in the discharge line at the outlet from the compressor.
25. Heat Exchanger - apparatus in which heat is exchanged from one fluid to another through a partition.
26. Heat, Latent - heat characterized by change of state of the substance concerned, for a given pressure and always at a constant temperature for a pure substance, i.e., heat of vaporization or fusion.
27. High Side - parts of refrigerating system under condenser pressure.
28. Infiltration - air flowing inward as through a wall, leak, etc.
29. Liquid Line - the tube or pipe carrying the refrigerant liquid from the condenser or receiver of a refrigerating system to a pressure-reducing device.
30. Low Side - parts of a refrigerating system under evaporator pressure.
31. Pressure Drop - loss in pressure, as from one end of a refrigerant line to the other, due to friction, etc.
32. Refrigerating System - a combination of inter-connected refrigerant-containing parts in which a refrigerant is circulated for the purpose of extracting heat.
33. Respiration - production of CO₂ and the heat by ripening of perishables in storage.
34. Return Air - air returned from conditioned or refrigerated space.
35. Sensible Heat - heat which is associated with a change in temperature; specific heat x change of temperature; in contrast to a heat interchange in which a change of state (latent heat) occurs.
36. Specific Heat - energy per unit of mass required to produce one degree rise in temperature, usually BTU per lb. degree F. numerically equal to cal. per gram degree C.
37. Standard Air - air weighing 0.075 lb. per cu. ft. which is closely air at 68°F. dry bulb and 50% relative humidity at barometric pressure of 29.92 in. of mercury of approximately dry air at 70°F. at the same pressure.
38. Suction line - the tube or pipe which carries the refrigerant vapor from the evaporator to the compressor inlet.
39. Superheat - temperature of vapor above its saturation temperature at that pressure.
40. Temperature, Wet-Bulb - equilibrium temperature of water evaporating into air when the latent heat of vaporization is supplied by the sensible heat of air.
41. Thermal Valve - a valve controlled by a thermally responsive element, for example, a thermostatic expansion valve which is usually responsive to suction or evaporator temperature.
42. Throw - the distance air will carry, measured along the axis of an air stream from the supply opening to the position, is the stream at which air motion reduces to 50 fpm.
43. Ton of Refrigeration - a rate of heat interchange of 12,000 BTU per hour; 200 BTU per min.
44. Unit Cooler - adapted from unit heater to cover any cooling element of condensed physical proportions and large surface generally equipped with fan.

Quick Selection Guide

BTUH Load											
Dimension	Floor Sq. Ft.	+35 Room Usage		+30 Room Usage		0 Room Usage		-10 room Usage		-20 Room Usage	
		Avg.	Heavy	Avg.	Heavy	Avg.	Heavy	Avg.	Heavy	Avg.	Heavy
6x6x8	36	4750	6389	4488	6037	4583	6505	4929	7041	5274	7577
6x8x8	48	5417	7274	5119	6974	5225	7407	5630	8028	6034	8648
6x10x8	60	6055	8100	5722	7655	5806	8213	6265	8911	6725	9609
8x8x8	64	6188	8291	5848	7835	5934	8410	6405	9127	6876	9844
8x10x8	80	6954	9269	6572	8759	6631	9363	7165	10169	7699	10974
8x12x8	96	7669	10174	7247	9614	7273	10234	7867	11123	8461	12011
8x14x8	112	8366	11045	7905	10437	7922	11092	8575	12059	9227	13026
8x16x8	128	9051	11888	8553	11234	8528	11890	9237	12933	9946	13976
8x18x8	144	9748	12732	9212	12032	9169	12732	9936	13852	10702	14972
8x20x8	160	10419	13548	9846	12803	9755	13490	10576	14682	11397	15874
8x22x8	176	11540	14807	10905	13992	10817	14715	11692	15977	12567	17239
8x24x8	192	12224	15622	11522	14763	11386	15439	12314	16769	13242	18099
8x26x8	208	12874	16398	12166	15496	11976	16176	12955	17573	13935	18970
8x28x8	224	13519	17163	12775	16219	12530	16873	13562	18336	14594	19799
8x30x8	240	14187	17947	13407	16960	13108	17587	14191	19115	15274	20642
8x32x8	256	14824	18694	14009	17666	13653	18264	14786	19855	15920	21446
10x10x8	100	7789	10339	7361	9770	7386	10401	7990	11304	8594	12208
10x12x8	120	8626	11385	8152	10759	8138	11405	8809	12401	9481	13397
10x14x8	140	9439	12384	8920	11703	8887	12405	9626	13493	10365	14581
10x16x8	160	10250	13379	9686	12643	9577	13311	10379	14484	11182	15658
10x18x8	180	11049	14349	10441	13560	10279	14216	11144	15472	12009	16728
10x20x8	200	11838	15299	11187	14458	10942	15070	11868	16405	12794	17741
10x24x8	240	13391	17180	12654	16207	12751	17231	13796	18721	14842	20211
10x28x8	280	14891	18922	14072	17881	14043	18844	15205	20482	16367	22120
12x12x8	144	10038	13021	9486	12305	8991	12553	9739	13655	10486	14756
12x14x8	168	10956	14155	10353	13376	10235	14052	11055	15251	11875	16450
12x16x8	192	11886	15284	11232	14443	11029	15082	11919	16375	12810	17667
12x18x8	216	12775	16359	12072	15459	11807	16080	12767	17464	13726	18847
12x20x8	240	13681	17440	12928	16481	12573	17052	13599	18524	14626	19995
12x22x8	264	14549	18474	13749	17458	13299	17974	14392	19541	15485	21088
14x14x8	196	11993	15423	11333	14575	11126	15216	12024	16521	12923	17826
14x16x8	224	13013	16656	12297	15740	11995	16338	12971	17745	13946	19152
14x20x8	280	15011	19042	14185	17795	13687	18487	14811	20088	15935	21688
14x24x8	336	16969	21347	16036	21073	15330	20539	16598	22324	17866	24110
16x16x8	256	14148	18019	13370	17028	12939	17550	13998	19067	15056	20583
16x20x8	320	16349	20631	15450	19496	14777	19873	15996	21598	17215	23323
16x24x8	374	18506	23157	17488	21883	16563	22093	17938	24017	19313	25941
18x18x8	324	16476	20782	15570	19639	14864	19989	16090	21724	17317	23460
18x20x8	360	18128	22644	17131	21398	16305	21678	17617	23523	18930	25369
18x24x8	432	20484	25389	19357	23993	18260	24090	19739	26149	21219	28208
20x20x8	400	19470	24145	18340	22817	17386	23019	18790	24982	20194	16945
20x24x8	480	21988	27132	20779	25640	19453	25566	21036	27755	22619	29945
20x28x8	560	24963	30480	23590	28804	21963	28514	23721	30922	25479	33330
20x32x8	640	27480	33340	25969	31506	23954	30909	25884	33529	27813	36149
20x36x8	720	29946	36127	28299	34140	25919	33251	28017	36077	30115	38903
20x40x8	800	32420	38904	30637	36764	27888	35575	30153	38603	32518	41631
24x40x8	960	38694	45735	36565	46878	34681	43023	37368	46538	39939	49937
28x40x8	1120	43183	50733	40808	48970	38123	47062	41095	50921	43950	54664
32x40x8	1280	48550	56318	45880	55056	42894	51900	46146	56580	49282	60656
36x40x8	1440	54344	62804	51355	61626	46254	56259	49872	60781	53194	65186
40x40x8	1600	58738	67611	55507	66608	49583	60073	53385	64916	57070	69642

*Heavy usage is defined as two times the average air change. Average air changes determined by ASHRAE based on box size for 24 hour period.

Tips for Quick Selection Guide

Walk- In Cooler Box Load Parameter

1. 95°F. ambient air temperature surrounding box.
2. 4" Styrene (R=16.7, K=0.24) walls/ceiling, 6" concrete slab floor.
3. Average product load with 5°F. pull down in 24 hours.
4. BTUH load based on 16-18 hour compressor run time for 35°F. box (timer recommended) +20 hours for 30°F. box.
5. See Table C for adjustment to box load for glass doors.
6. For 80°F. ambient temp. surrounding box, deduct 12%.
7. For 4" Urethane walls+ceiling, 6" concrete slab floor deduct 12%.
8. For 10' ceiling height add 10%.
9. For additional BTUH load for product cooling see Table A.

Walk-In Freezer Box Load Parameters

1. 95°F. ambient air temperature surrounding box.
2. 4" Urethane (R=25, K=0.16) walls, ceiling + floor.
3. Average product load with 10 degree pull down in 24 hours.
4. BTUH load based on 18 hour compressor run time.
5. See Table C for adjustment to box load for glass doors.
6. For 80°F. ambient air temp. surrounding box, deduct 12%.
7. For 20 hour compressor run time (light frost load) in lieu of 18 hour run time, deduct 11%.
8. For 10' ceiling height add 10%.
9. For additional BTUH load for product freezing, refer to Table D

Table A

Product Cooling Loads for Walk-In Coolers

(24 hour pull down/18 hour compressor operation) 24% safety factor added to loads to allow for service.

Product	Specific Heat Above Freezing	10 Degree Pull down BTUH Load for Indicated lbs of Product per 24 Hours					
		500	1000	1500	2000	3000	5000
Beef	0.72	240	480	720	960	1440	2400
Pork	0.53	177	353	530	706	1060	1767
Veal & Lamb	0.76	253	506	760	1012	1520	2533
Poultry	0.79	263	526	790	1053	1580	2633
Seafood	0.80	267	533	800	1066	1600	2667
Vegetables	0.92	307	613	920	1226	1840	3067
Bakery Food	0.74	247	494	740	988	1480	2467
Beer	1	333	666	1000	1333	2000	3333

For product pull down greater than 10 degrees, divide pull down temperature by 10. Multiply this number by the BTUH shown on Table A, then add to Box Load

Table B

Meat Cutting/Prep Room Load (BTU/HR/SQ FT of floor area)

Floor SQ FT	Approx. 65% R.H. Room Temp.		Room Loads based on continuous operation and includes allowance for average number of personnel, processing equipment, etc., with glass panel in one wall and walls and ceiling insulated with 3" of styrene with box located in air conditioned area. Evaporator should be low outlet velocity type to avoid drafts and should be selected for continuous operation and not less than 30°F. evap. temp.
	55°F.	50°F.	
100	93	105	
200	88	99	
300	85	95	
400	81	90	
500	78	87	
600	75	85	
700	72	81	
800	69	78	
900	67	75	
1000	65	73	
1200	62	69	

Table C

Glass Door Loads

Box Temperature	BTU per Door
+35	1060
+30	960
0	1730
-10	1730
-20	1730

* Adjusted for 16-18 hour run time. Multiply number of doors times door load above and add to box load.

Table D

Product Freezing Loads for Walk-In Freezers

Product	Spec. Heat BTU/lb/Deg. F.Heat		Latent Temp. BTU/lb.	Freezer -10°F. Freezer Temperature (F)	Freezer Temperature BTUH for Indicated lbs. Prod/Day					
	32 +	32 -			100	300	750	1000	1500	3000
Beef	0.72	0.40	95	29	790	2370	5925	7900	11850	23700
Pork	0.53	0.32	60	28	523	1571	3926	5235	7853	15710
Veal & Lamb	0.76	0.45	100	28	841	2524	6311	8414	12621	25240
Poultry	0.79	0.42	106	27	878	2636	6590	8787	13181	26360
Seafood	0.80	0.43	110	28	906	2719	6797	9063	13595	27190
Vegetables	0.92	0.47	130	30	1053	3159	7898	10530	15795	31590
Bakery Foods	0.74	0.34	53	20	520	1560	3900	5200	7800	15600

Freezing loads based on product entering at 40°F. maximum. For a specific pull down time, the product load BTU/hr. may be adjusted by multiplying the above loads by 24 and dividing by

the specific pull down time in hours. To adjust for 0°F. freezer temperature, multiply the above loads by 0.97, and for -20°F. freezer, multiply by 1.04.

Rapid Load Calculator for Large Coolers and Freezers

Design Conditions: 95°F. ambient; heavy service; 16-hr. compressor running time; average number of lights, motors, and people; product load figured according to accompanying table; product traffic calculated at 30 degree temperature reduction for coolers, 10 degree temperature reduction for freezers.

Note: This calculator will work equally well for coolers and freezers, providing the room is insulated as indicated below:

35°F. cooler- 3"	polystyrene or equivalent
30°F. cooler- 4"	polystyrene or equivalent
0°F. cooler- 5"	polystyrene or equivalent
-10°F. cooler- 5 1/2"	polystyrene or equivalent
-20°F. cooler- 6"	polystyrene or equivalent

Example: 100 x 40 x 20' zero °F. freezer. Outside surface totals 13,600 sq. ft. Find 13,600 sq. ft. outside surface line at left of graph. Follow it across to the straight line curve. Then drop down to total load line at bottom of graph. Total load for this example is 224,000 BTUH. Select equipment accordingly.

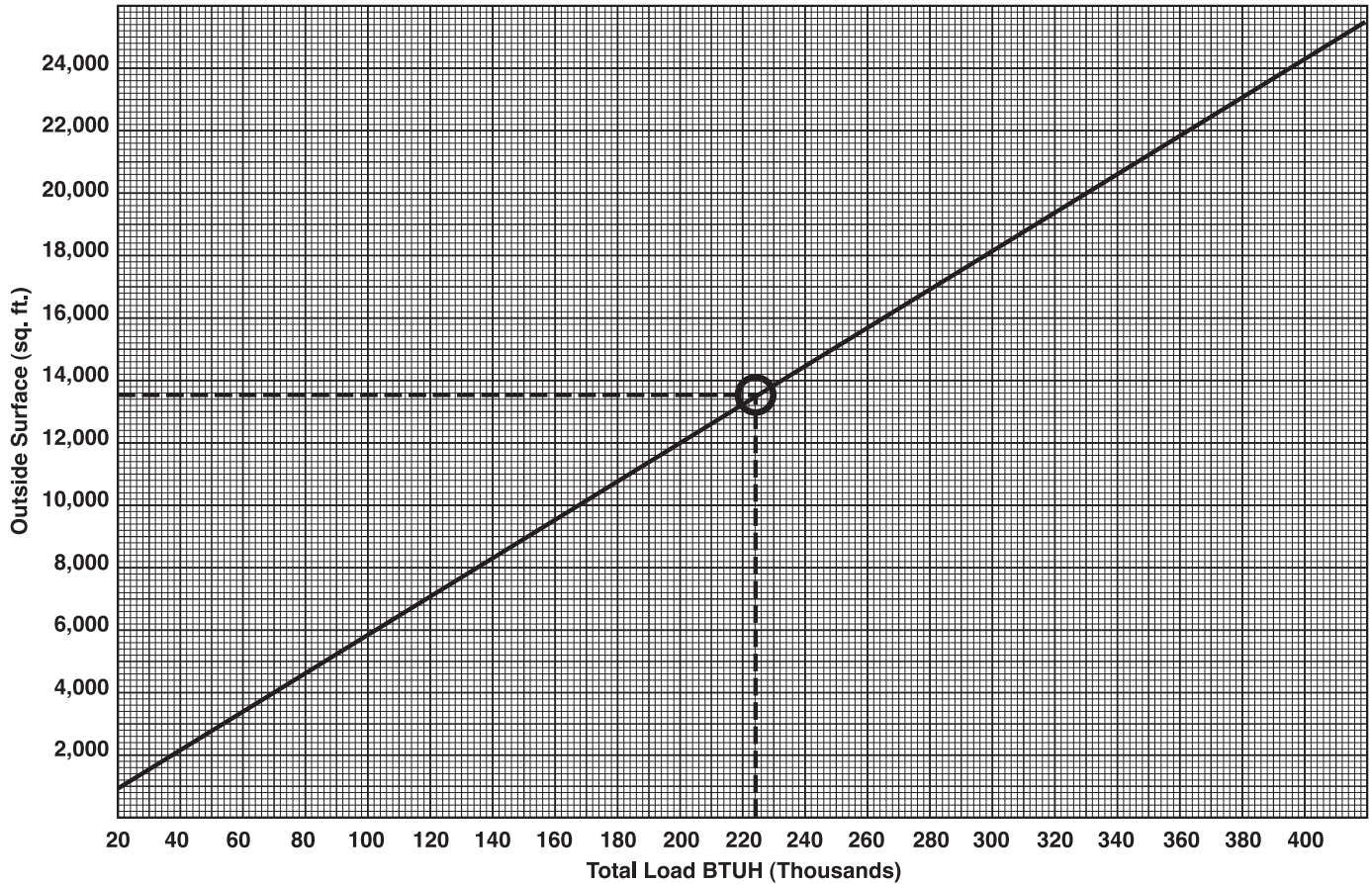

Material originated by Hugo Smith, consulting editor, Air Conditioning and Refrigeration Business. Reprinted by permission from the April 1968 issue of Air Conditioning and Refrigeration

Business. Copyright by Industrial Publishing Co., Division of Pittway Corporation.

Volume- Cu. Ft.	Average Daily Product Loads (lbs.) for Coolers	Average Daily Product Loads (lbs.) for Freezers
500 - 3,000	6,200 - 8,000	1,600 - 2,000
3,000 - 4,600	8,000 - 11,000	2,000 - 2,500
4,600 - 8,100	11,000 - 17,000	2,500 - 4,000
8,100 - 12,800	17,000 - 26,000	4,000 - 6,200
12,800 - 16,000	26,000 - 33,000	6,200 - 7,500
16,000 - 20,000	33,000 - 40,000	7,500 - 9,500
20,000 - 28,000	40,000 - 56,000	9,500 - 13,000
28,000 - 40,000	56,000 - 66,000	13,000 - 17,000
40,000 - 60,000	66,000 - 110,000	17,000 - 25,000
60,000 - 80,000	110,000 - 150,000	25,000 - 34,000
80,000 - up	150,000 - up	34,000 - up

Since product improvement is a continuing effort, we reserve the right to make changes in specifications without notice.

Heatcraft Refrigeration Products LLC

2175 West Park Place Blvd • Stone Mountain, GA 30087

Phone: 800.321.1881 • Fax: 770.465.5990 • www.heatcrafttrpd.com

The name behind the brands you trust.™

